

OCTOBER 2023

MASON CLARK AND KAROLINA HIRD

RUSSIAN REGULAR GROUND FORCES ORDER OF BATTLE



The background of the entire page is a detailed topographic map, showing contour lines and terrain features. The map is rendered in a light, monochromatic style, with the lines and shading providing a complex, textured backdrop for the text.

MASON CLARK AND KAROLINA HIRD

RUSSIAN REGULAR GROUND FORCES ORDER OF BATTLE

Russian T-80 tanks take part in the 'Vostok-2022' military exercises at the Uspenovskiy training ground (Sakhalin Island) outside the city of Yuzhno-Sakhalinsk on the Russian Far East on September 4, 2022. - The Vostok 2022 military exercises, involving several Kremlin-friendly countries including China, takes place from September 1-7 across several training grounds in Russia's Far East and in the waters off it. Over 50,000 soldiers and more than 5,000 units of military equipment, including 140 aircraft and 60 ships, are involved in the drills. (Photo by Kirill KUDRYAVTSEV / AFP) (Photo by KIRILL KUDRYAVTSEV/AFP via Getty Images).

©2023 by the Institute for the Study of War.

Published in 2023 in the United States of America by the Institute for the Study of War.

1400 16th Street NW, Suite 515 | Washington, DC 20036

understandingwar.org

ABOUT THE AUTHORS

Mason Clark is a Senior Analyst and the Russia Team Lead at the Institute for the Study of War. He has led ISW's standard-setting coverage of the Russian invasion of Ukraine since the operation was still in its planning stages. His research focuses on Russian military capabilities and learning, Kremlin integration efforts in the former Soviet Union and Russian strategic calculus. Mason received a B.A. with Honors in International Studies with a focus on US Foreign Policy and Russian from American University's School of International Service.

Karolina Hird is a Russia Deputy Team Lead, Analyst, and Evans Hanson Fellow at the Institute for the Study of War. Karolina is a senior member of the team that has produced the daily Russian Campaign Assessments since spring 2022. Karolina particularly focuses on Russian operational campaign design and the humanitarian aspects of the war in Ukraine, particularly the issue of forced deportations and adoption of Ukrainian children. Karolina received a BA in International Affairs from The George Washington University, where she focused on international security, international law, and gender analysis.

ACKNOWLEDGMENTS

The authors would like to thank the incredible combined teams at ISW and the Critical Threats Project (CTP) without whom this report would not have been possible. We would like to thank ISW President Dr Kim Kagan for her support and mentorship, and to thank CTP Director Dr Fred Kagan for his review of the text and guidance. We are particularly grateful to Russia Analyst and Geospatial Intelligence Team Lead George Barros, as well as Geospatial Team Researchers Noel Mikkelsen and Thomas Bergeron, for their analytical help and assistance with the mapping and visual elements of this project. We would like to thank Suchy Design for designing this report, and Alex Mitchell and the ISW External Relations team for publishing and promotion. Finally, we are extremely grateful to the entire ISW Russia Team, including the Spring and Summer 2023 intern classes, without whom this work would not have been possible.

ABOUT THE INSTITUTE

ISW is a non-partisan and non-profit public policy research organization. It advances an informed understanding of military affairs through reliable research, trusted analysis, and innovative education. It is committed to improving the nation's ability to execute military operations and respond to emerging threats in order to achieve the strategic objectives of the US around the globe.

RUSSIAN REGULAR GROUND FORCES ORDER OF BATTLE:

ISW believes that superior strategic insight derives from a fusion of traditional social science research and innovative technological methods. ISW and CTP recognize that the analyst of the future must process a wide variety of information ranging from interviews and historical artifacts to high-volume structured data. ISW and CTP thank their technology partners for their support in this innovative endeavor.



Neo4j: Neo4j is a highly scalable native graph database that helps organizations build intelligent applications to meet evolving connected data challenges including fraud detection, tax evasion, situational awareness, real-time recommendations, master data management, network security, and information technology operations. Global organizations like MITRE, Walmart, the World Economic Forum, UBS, Cisco, HP, Adidas, and Lufthansa rely on Neo4j to harness the connections in their data.



Ntrepid: Ntrepid enables organizations to conduct their online activities safely. Ntrepid's NFusion leverages the company's platform and fifteen-year history protecting the national security community from their most sophisticated global opponents. From corporate identity management to secure browsing, Ntrepid products facilitate online research and data collection and eliminate the threats that come with having a workforce connected to the Internet.



Linkurious: Linkurious provides graph visualization software that helps organizations detect and investigate insights hidden in graph data. Linkurious supports government agencies and global companies in a range of applications from anti-money laundering and cyber-security to medical research. Linkurious makes complex connected data easy to understand for analysts.



Microsoft: Microsoft helps empower defense and intelligence agencies with its deep commitments to national security, trust, innovation, and compliance. With world-class security and a wide array of cloud services designed for mission success, the Microsoft Cloud offers a cloud platform designed for flexibility and scale to strengthen partnerships and alliances, create smart work environments and installations, and optimize operations to better meet mission needs and help foster a safer, more secure world.



Sayari: Sayari is a search company, not a traditional data vendor. They build search products that allow users to find corporate, financial, and public records in hard-target countries. Sayari products cover emerging, frontier, and offshore markets, and include corporate registries, official gazettes, litigation, vital records, customs data, and real property. They collect, structure, normalize, enrich, and index this data, often making it searchable for the very first time.



BlackSky: BlackSky integrates a diverse set of sensors and data unparalleled in the industry to provide an unprecedented view of your world. They combine satellite imagery, social media, news and other data feeds to create timely and relevant insights. With machine learning, predictive algorithms, and natural language processing, BlackSky delivers critical geospatial insights about an area or topic of interest and synthesizes data from a wide array of sources including social media, news outlets, and radio communications.



Semantic AI: By combining semantics with entity, path, link and social network analytics, Semantic AI adds a layer of intelligence to make rapid contextual connections throughout vast amounts of disparate data. The Semantic AI™ Platform is designed for augmented human intelligence in the Artificial Intelligence age. This adaptable investigation, analytics and intelligence environment allows users to quickly analyze situations, redirect investigative focus and dive deeply into the most relevant connections.



BabelStreet: Provides the most advanced identity intelligence and risk operations platform for the world's most trusted government and commercial organizations. The AI-enabled platform helps them stay informed and improves around-the-clock decision-making. Teams are empowered to rapidly detect and collaborate on what matters in seconds by transforming massive amounts of multilingual, enterprise and publicly available data into actionable insights so they can act with confidence. Babel Street is headquartered in the U.S. with offices near Washington, D.C., and Boston, along with Tokyo, Tel Aviv, London, Canberra, and Ottawa. For more information, visit babelstreet.com.

Table of Contents

8	Introduction to The Contents of This Report
10	Russian Military IOI
15	Russia's Regular Ground Forces Order of Battle
43	Appendix A: Glossary of Russian Unit Types
44	Appendix B: Bibliography and Further Reading
46	Endnotes

Introduction to The Contents of This Report

This report contains two sections: an introductory essay on the regular Russian ground forces; and a fully sourced order of battle (ORBAT) of Russia's regular ground forces down to the brigade and regiment echelon (with select independent battalions), including the army, ground forces controlled by the the navy, VDV (Airborne) units, and GRU Spetsnaz formations.¹

The following essay is intended as an introduction to the regular Russian ground forces for security studies professionals, policymakers, and journalists who are not necessarily Russia specialists. This report covers the federal-level structure of Russia's armed services and General Staff; Russia's personnel system; general characteristics of Russian ground capabilities; Russian organizational structure from the Military District to the brigade/regiment level; and a brief discussion of the Battalion Tactical Group (BTG). This report draws on the sources in the accompanying annotated bibliography and the authors' study of the Russian armed forces, supplemented where necessary with footnotes exploring exceptions and adding further context.

This order of battle of the Russian regular ground forces is ISW's assessment of the on-paper structure of the regular Russian ground forces as of January 2023. It covers the Army, ground forces of the Navy, VDV, and GRU Spetsnaz down to the regiment and brigade level. It does not cover the Aerospace (VKS) forces (including air and air defense armies); Navy surface warfare and submarine assets; or the strategic rocket forces. We have excluded the 1st and 2nd Army Corps (the armed forces of the Donetsk People's Republic [DNR] and Luhansk People's Republic [LNR], informally run by the Southern Military District [SMD] since 2014 and formally acknowledged as such in December 2022) and the 3rd Army Corps (a new formation of volunteer units created under the Western Military District [WMD] in June 2022)

from this regular forces ORBAT. While these formations are part of the Russian Army on paper, we assess that they are closer in organization and purpose to irregular formations such as PMCs, Rosgvardia, BARS Combat Reserve units, and other forces. We will assess the structure and capabilities of these three Corps in our forthcoming irregular Russian ground forces ORBAT and the capstone forecasting report in this series.

This ORBAT is intended to provide an updated open source baseline of the Russian ground forces and is intentionally backdated to January 2023. Existing open source ORBATs of the Russian ground forces are missing several units, do not provide individual sourcing for each unit, and largely leverage the now defunct mikavkaz.com. This report does not address Defense Minister Sergei Shoigu's intended force changes announced in January 2023, including the reintroduction of the Leningrad and Moscow Military Districts and the intended formation of 12 new maneuver divisions. It also does not attempt to assess the actual strength of highly degraded Russian units. While the Russian military is in the process of establishing these new formations and in some cases already deploying them to Ukraine, we elected to provide a fully sourced baseline to support future ISW reports and as an open source baseline for practitioners other researchers.

All units are listed with their formal title, B/Ч number ("voyskovaya chast" or "military unit," a

¹ Russia's Army – one of the three main services – is formally known as the Ground Forces of the Russian Federation. This report will refer to this service as the "Russian Army" for clarity. The lower-case term "ground forces" is used to refer to all of Russia's regular conventional ground units, including the Army, ground formations controlled by the Navy, and the Airborne Forces (VDV).

unique five-digit numerical code assigned to each administrative entity in the Russian armed forces), and permanent basing location, when confirmable. Units that we assess likely exist but whose existence we cannot confirm are listed in [brackets]. The authors developed this ORBAT by using strictly open sources to confirm the existence and permanent basing locations of Russian regular ground forces units. The authors focused on all maneuver and combat support units at the regiment and brigade level and above, with the exception of a few significant battalion-level units. The majority of units are multi-sourced with data identifying their name and basing location. The authors endeavored to include two reliable sources since 2021 per listed unit, but this standard was not tenable for many combat support elements and units from less

well-resourced military districts, in which case the sourcing standard was amended to allow for sourcing since 2013. Leveraged sources include news articles from both local and state outlets; government press releases; blogs and commentary pages run by military enthusiasts or veterans of given units; social media outlets (such as Odnoklassniki [OK] and VKontakte [VK]); address registration pages; local government bulletins; and various message boards. A small number of units, primarily combat support elements, only include one source due to limited data meeting these standards confirming their basing. **All sources used for each individual unit are available in the endnotes of the text ORBAT later in this report.**

Russian Military IOI

Structure of the Russian Armed Forces: Ministry of Defense, General Staff, and Services

The Russian Armed Forces are administratively controlled by the Russian Ministry of Defense (MoD), with longstanding Defense Minister Sergei Shoigu reporting to President Vladimir Putin and sitting on the Security Council, the Russian President's consultative body on national security. Shoigu runs the MoD through the Collegium, a standing body including several Deputy Defense Ministers, the heads of key MoD and General Staff Directorates, the commanders of Russia's armed services and branches, and the Military District commanders.

The Russian General Staff is the executive body of the MoD. The Russian General Staff is often misunderstood by Western observers and differs from the US Joint Staff in several key ways.¹¹ Often referred to as the "Arbat Military District" for the street in Moscow its headquarters is located on, the General Staff exerts a powerful influence on Russian military planning and was a major force behind resistance to previous Defense Minister Anatoly Serdyukov's "New Look" reforms.

The General Staff is responsible for strategic defense planning – forecasting the wars Russia will likely need to fight; assessing predominant means of warfare; and developing the Russian military necessary to meet these requirements, in addition to holding operational control over Russian forces in wartime. The Chief of the General Staff – currently Army General Valery Gerasimov, who has served in this role since 2012 – has command authority over the entire Russian Armed Forces. He is, in this respect, very different from the US Chairman of the Joint Chiefs of Staff, who is explicitly by law excluded from the operational chain of command. Gerasimov holds operational command through

the dual chain of the armed services (which retain administrative control) and the Military Districts, as well as direct control of strategic forces including the Strategic Rocket Forces, GRU Spetsnaz, and VDV (Airborne Forces). The structure of the General Staff itself, the changes in the Russian high command enacted during the war in Ukraine, and likely future developments will be addressed in ISW's forthcoming General Officers Guide.

Russia's armed services report to the General Staff. The Russian Armed Forces have three main services: the army, navy, and aerospace forces, which organize their forces under the Military District structure discussed below. Russia also possesses two "separate service branches" – the Airborne Forces, or VDV (for "Vozdushno-Desantnye Voiska" or "air landing troops"); and the Strategic Rocket forces, which control Russia's intercontinental ballistic missiles (ICBMs). Formations from these two services are *not* subordinate to Military Districts, but rather report through their respective commanders directly to the General Staff. Russia's Special Operations Forces and GRU Spetsnaz also report directly to the General Staff. Russia additionally has several security forces with combat capabilities often close to those of army motorized rifle units but with chains of command outside of the Ministry of Defense, such as Rosgvardia and the FSB Border Service, which are not covered in this report.

Three services of the Russian Armed Forces field Russia's regular ground forces: the Army, VDV, and Navy.

The Russian Army is the indisputable heart of the Russian armed forces, and, naturally, of its ground forces. Army officers exert the greatest influence over the Russian armed forces and occupy most key positions on the General Staff and in Military District command positions. The Russian military

¹¹ For more information on the formal structure and likely influence of the Russian General Staff on Russian policymaking, see Alexis A. Blanc, Alyssa Demus, Sandra Kay Evans, Michelle Grisé, Mark Hvizda, Marta Kepe, Natasha Lander, and Krystyna Marcinek, "The Russian General Staff: Understanding the Military's Decisionmaking Role in a 'Besieged Fortress,'" RAND Corporation, May 15, 2023, https://www.rand.org/pubs/research_reports/RR1233-7.html.

is a joint force, but the army is at the top of a functional “hierarchy of jointness” and dominates military thinking, spending, and operations.^{III} Army units are predominantly divided into tank (armored) and motorized rifle (mechanized infantry) units, with a few exceptions discussed in the unit glossary of this report.

The VDV (Russia’s airborne forces) uniquely has the status of a service of the armed forces, rather than being a branch of the army as in the US and most other militaries. VDV units are generally the most professional, best trained, and best equipped units in the Russian military. The VDV is a strategic asset not tied to the geographical Military Districts and reports directly to the General Staff. VDV divisions and brigades are intended as a rapid reaction and expeditionary force in small wars, and a combination of strategic reserve and penetration force in large conventional wars. In practice, they have been pressed into service and employed as relatively light infantry throughout Russia’s 21st century wars as the highest readiness and most effective infantry available, compared to the motorized rifle troops. VDV units are notably fully mechanized, and far “heavier” than the light infantry units that comprise Western airborne formations. VDV units operate expensive and specialized vehicles with near-equivalent firepower but far less armor than Army vehicles in order to retain nominal air mobility.

Russia’s naval fleet headquarters report to the Military District structure and both operate their own naval infantry (marine) units as well as command ground forces through Army Corps headquarters subordinated to the fleets. The Naval Infantry are a relatively elite force with amphibious capabilities that have not yet been extensively demonstrated in combat. Like VDV and Army units, they are fully mechanized and in Ukraine have been leveraged as a primary infantry force over less-capable motorized rifle formations, similar to key VDV units. The

Black Sea, Baltic, Northern, and Pacific Fleets each additionally control a mix of regular motorized rifle and “coastal defense” units (the latter of which are trained and equipped as motorized rifle units) both directly through the fleet HQ’s and “Army Corps” - formations roughly equivalent to small Combined Arms Armies.

Staffing and General Characteristics of the Russian Ground Forces

The Russian military is staffed by a hybrid of long-service professionals referred to as “kontraktniki” (“contract servicemen”) and a legacy Soviet-style cadre and reserve system of conscripts serving one-year terms on a semi-annual cycle.^{IV} MoD decision making on staffing the Russian military in the 21st century has been dominated by two competing considerations: the goal of creating a smaller, flexible, and more technically advanced military of volunteer professionals (as epitomized by former Defense Minister Anatoly Serdyukov’s 2008-2009 “New Look” reforms); and the desire to retain the Soviet capability of generating large conscript forces for large-scale conventional warfare with NATO.

All Russian units are comprised of a mix of contract servicemen and officer cadres intended to be filled out with conscripts in wartime. Some units (such as key VDV units like the 76th Airborne Division and Naval Infantry brigades) are more contractor-heavy than others, but no units at the brigade and regiment level and above are wholly comprised of contract personnel. Even elite VDV units contain conscripts, albeit the cream of the crop of each call-up. Contract servicemen fill specialist and “trigger puller” positions and typically remain in the same specialty for the duration of their careers. Conscripts fill out support and rifleman positions. In the event of large-scale war, the Russian military is theoretically supposed to fill out its units with

III Credit for the apt term “hierarchy of jointness” goes to Mykhaylo Zabrodskyi, Jack Watling, Oleksandr V. Danylyuk, and Nick Reynolds, “Preliminary Lessons in Conventional Warfighting from Russia’s Invasion of Ukraine: February-July 2022,” Royal United Services Institute, November 30, 2022, <https://static.rusi.org/359-SR-Ukraine-Preliminary-Lessons-Feb-July-2022-web-final.pdf>, pg 44-45.

IV For coverage of the Russian Armed Forces’ mixed contractor and conscript system, see Mark Galeotti, *Putin’s Wars: From Chechnya to Ukraine* (Oxford: Osprey, 2022), pg 107-111; Lester W. Grau and Charles K. Bartles, “The Russian Way of War: Force Structures, Tactics, and Modernization of the Russian Ground Forces,” Foreign Military Studies Office, August 22, 2017, <https://www.armyupress.army.mil/portals/7/hot%20spots/documents/russia/2017-07-the-russian-way-of-war-grau-bartles.pdf>, pg. 3-9; Gil Barndollar, “The Best or Worst of Both Worlds?” Center for Strategic & International Studies, September 23, 2020, <https://www.csis.org/blogs/post-soviet-post/best-or-worst-both-worlds>.

a callup of reservists (those who previously served as conscripts), which Russia elected not to do fully prior to February 2022. The Kremlin's decision not to mobilize fully before the 2022 invasion of Ukraine and efforts to avoid a full mobilization has undermined the staffing of Russian units and led to a dearth of much-needed infantry.^V

The modern Russian ground forces retain strong elements of their Soviet legacy in terms of doctrine, equipment, and approach to combat operations. Very little can spark fiercer debate amongst observers of the Russian military than the degree of this Soviet influence, but many of the tactical and operational capabilities of the modern Russian military are continuations of the Soviet period, with mixed progress towards improved C2; a greater but still limited profusion of precision weaponry; and the development of the kontraktniki model.

Much of the doctrine and intended capabilities of the Russian ground forces flows from the Cold War-era mission of a rapid, mechanized drive across Western Europe. Mass and speed were paramount – fires would clear NATO positions and fully mechanized ground forces would remain mounted as much as possible. On the offense, Russian artillery and direct fires are intended to destroy opposing formations and enable rapid, mechanized maneuver into enemy rear areas. On the defense, Russian units are adept at digging in quickly and for protracted periods, as seen in Ukraine. Modernization of the ground forces in the last decade has been uneven due to budget and industrial constraints, with the majority of units operating upgraded Soviet kit. Most development has been centered on C2, EW, and long-range fires such as ballistic missile formations intended to provide some precision capabilities to destroy enemy C2 and key assets.^{VI}

The Russian military has an outwardly formulaic and static approach to war that is intended to minimize the weaknesses of individual conscripts and leverage mass to enable operational flexibility.^{VII} Russian officers are taught a mathematical approach to war, wherein the correct tactical drill and a mathematically precise amount of combat power can be applied to a combat situation to ensure success. Mathematical models abound in Russian military science, with every possible input theoretically accounted for. Russian personnel are taught a wide array of tactical drills they can execute mechanically, and officers learn a deep but static playbook of formulae to aid planning and execution. This tactical rigidity is intended to enable operational flexibility, as commanders can build basic but well-known tactical drills into complex plans based on a mathematical evaluation of the enemy and likely outcomes. Working from a defined “menu” of tactical options means staff sizes and planning time requirements are much lower than in Western militaries. The Russian military's 21st-century efforts to develop “automated control systems” are intended to advance this line of thinking, leveraging computing power (and theoretically eventually AI) to increase the accuracy and speed through which commanders can select the “correct” option from a menu of drills. While the Russian military observed and discussed the need for flexibility and initiative in its operations in Syria, it has shown little intent to fully abandon this formulaic and mathematical approach to tactical decision making.

The old stereotype of the Soviet and Russian military being an artillery army with maneuver units attached remains largely true, and Russian units have far greater quantities of artillery than their NATO counterparts. The Russian military strongly believes in the ability of massed artillery fire to not simply disrupt but fully destroy targets through

V The Kremlin has instead elected to pursue an array of ad hoc and irregular force generation mechanisms. These include attempts to leverage the BARS (combat reserve) program; the formation of brand new “volunteer” units; reliance on the Wagner Group and increasingly other PMCs; leveraging and building out the forces of the DNR/LNR; using Rosgvardia and Spetsnaz units as line infantry; and blurring the lines between regular and irregular units. ISW will explore the implication of the Kremlin's decision to increasingly rely on irregular forces instead of leveraging its existing regular force generation structures in a forthcoming report.

VI The Russian Ministry of Defense often publishes percentages of the force as a whole and of specific units that are operating “modernized” equipment, an unclear adjective likely referring to equipment either newly-produced or upgraded to an undefined standard within roughly the past decade or so – such as the T-72B3 tank, a 2010 upgrade of the original model produced in the 1970s and the mainstay of Russian tank battalions.

VII This paragraph is written from an ideal Russian perspective, and should not be read as an evaluation of the practical effectiveness of this structure, which ISW will explore in future reports.

sheer weight of (predominantly area affect rather than precision) fires. Russian forces use artillery to accomplish many roles that NATO militaries would instead leverage air power for. The Russian ground forces are additionally on paper (and at the start of the 2022 invasion of Ukraine in practice) fully mechanized – including the VDV, Naval Infantry, and Spetsnaz. This focus on mounted operations has exposed gaps in Russian offensive capabilities in Ukraine. Most Russian infantry has been consistently reticent to dismount and clear Ukrainian positions if they cannot destroy defending Ukrainian units with fires, and Russian forces have struggled in situations requiring quality infantry, particularly in urban combat.^{VIII}

Structure of the Russian Ground Forces: Army to Battalion

Below the General Staff, the Russian military is organized into five Military Districts (as of the time of this publication, with the Western Military District due to be divided back into its pre-2010 structure of the Moscow and Leningrad Military Districts) which report to the General Staff and have operational control over their assigned forces in wartime.^{IX} In peacetime, Military Districts are administrative divisions responsible for training and development which cover areas of Russia, *not* areas of the globe like US Combatant Commands. Military Districts are joint headquarters controlling the forces in their respective regions, except for several strategic assets (the VDV, Strategic Rocket Forces, and GRU Spetsnaz). Military Districts are intended to operationalize into Joint Strategic Commands during wartime and serve as flexible structures able to integrate and command varied units from other Military Districts, strategic assets, and military forces beyond the Ministry of Defense such as Rosgvardia units. Russia apparently operationalized all four main military districts in 2022 at once and assigned them areas of responsibility in

Ukraine and has retained this model as “groupings of forces” commanded by elements of each Military District HQ (with some modifications, including the creation of a “Dnepr” group of forces) as of September 2023.

The primary formations of the Russian ground forces are the 12 combined arms armies (one of which is designated the 1st Guards Tank Army but is not structurally different from the CAAs). Armies are not standardized, with smaller Central Military District (CMD) and Eastern Military District (EMD) armies comprised of a few brigades and the main formations of the WMD and SMD commanding multiple large divisions. Army headquarters are intended to be flexible HQs that can run varied operations and take in new assets from other formations – such as the SMD’s 8th CAA command of Russian operations in the Donbas from 2014 to 2022, which included units from across Russia’s military districts. Armies importantly directly control logistics, artillery, and air defense units which are detached to support the maneuver divisions and brigades in combat. Russian Army Corps are collocated with and subordinate to fleet HQs and serve the same function as Army HQs, with strengths comparable to the smaller CMD and EMD CAAs.

The Russian army almost entirely eliminated its divisions and regiments in 2008 and replaced them with brigades, based on the assessment that the only wars Russia would need to fight would be small-scale local wars and that Russia would therefore be better served by smaller, more flexible, and more professional brigades. The Russian military has steadily brought back divisions as the MoD observed the need for formations intended to fight large-scale conventional wars, rather than solely the brigades intended for local wars. Russia now operates a mix of divisions and brigades. Russian tank and motorized divisions vary greatly in size and capabilities (like their parent armies) but are

VIII For more on Russian infantry tactics in Ukraine in 2023, see Jack Watling and Nick Reynolds, “Meatgrinder: Russian Tactics in the Second Year of Its Invasion of Ukraine,” Royal United Services Institute, May 19, 2023, <https://static.rusi.org/403-SR-Russian-Tactics-web-final.pdf>.

IX The current Military District structure – with Districts holding both administrative and operational control over their units – was created in 2010 with the consolidation of seven previous districts into the Western, Southern, Central, and Eastern Military Districts. The Northern Fleet Strategic Command was created in 2014 and promoted to a full Military District in January 2021, but remains last among equals with the four primary districts. Shoigu announced in January 2023 that the MoD will bring back the pre-2010 Leningrad and Moscow Military Districts by 2026, but we have observed no practical implementation of this initiative to date.

always comprised of subordinate regiments. Only the 150th Motorized Rifle (8th CAA) and 90th Guards Tank (41st CAA) Divisions contain the Soviet-era complement of four regiments, with the rest containing two to three regiments (and in some cases only one, for divisions still under formation) and necessary combat and noncombat support elements. VDV divisions are organized similarly, with two or three maneuver regiments in addition to support elements. Russian maneuver regiments are slightly smaller than brigades and are not designed to fight independently of their division HQ and support elements for protracted periods. Unlike in the US military, brigades are not part of divisions and instead report directly to Army HQs. Brigades are designed to be capable of independent action and contain their own support elements, unlike regiments.

The Russian military in practice deployed Battalion Tactical Groups (BTGs) from parent brigades and regiments as the primary maneuver element for much of the initial period of the 2022 invasion of Ukraine, though the explicit use of BTGs has diminished throughout the war. A brief introduction to the BTG follows, with further recommended readings included in the bibliography. BTGs have

existed in various forms since the Soviet era, were developed further in the early 21st century, and formed the primary Russian unit in the Donbas 2014-2016. Each brigade and regiment has the capability to “generate” one or two BTGs from its nominal four component battalions by assembling the contract personnel and most qualified officers of the parent units into reinforced battalions with attached artillery and support elements, intended to be capable of limited action independent from their parent unit. BTGs are theoretically task-organized and can vary widely in capabilities. BTGs enable peacetime brigades and regiments to generate deployable forces, at the cost of cannibalizing the rest of the parent units and imposing interoperability challenges between personnel assembled from varied peacetime battalions on often short notice. BTGs additionally notably expose Russian brigades and regiments to being rendered combat ineffective by the loss of key assets early – both key supporting elements as well as losses among the most experienced troops and commanders, who are assigned to the generated BTGs first and leave an ineffective shell behind when lost.

Russia's Regular Ground Forces Order of Battle

Western Military District

1st Guards Tank Army, В/ч 73621 — Bakovka, Moscow Oblast¹

2nd Guards Motorized Rifle Division, В/ч 23626 — Kalininets, Moscow Oblast²

- 1st Guards Motorized Rifle Regiment, В/ч 31135 — Kalininets, Moscow Oblast³
- 15th Guards Motorized Rifle Regiment, В/ч 31134 — Kalininets, Moscow Oblast⁴
- 1st Tank Regiment, В/ч 58198 — Kalininets, Moscow Oblast⁵
- 136th Reconnaissance Battalion, В/ч 51387 — Kalininets, Moscow Oblast⁶
- 147th Self-Propelled Artillery Regiment, В/ч 73966 — Kalininets, Moscow Oblast⁷
- 1174th Anti-Tank Battalion, В/ч 51381 — Kalininets, Moscow Oblast⁸
- 1117th Anti-Aircraft Missile Regiment, В/ч 51382 — Golitsyno, Moscow Oblast⁹

4th Guards Tank Division, В/ч 19612 — Naro-Fominsk, Moscow Oblast¹⁰

- 12th Guards Tank Regiment, В/ч 31985 — Naro-Fominsk, Moscow Oblast¹¹
- 13th Guards Tank Regiment, В/ч 32010 — Naro-Fominsk, Moscow Oblast¹²
- 423rd Motorized Rifle Regiment, В/ч 91701 — Naro-Fominsk, Moscow Oblast¹³
- 137th Reconnaissance Battalion, В/ч 54919 — Naro-Fominsk, Moscow Oblast¹⁴
- 275th Self-Propelled Artillery Regiment, В/ч 73941 — Naro-Fominsk, Moscow Oblast¹⁵
- 49th Anti-Aircraft Missile Brigade, В/ч 21555 — Smolensk, Smolensk Oblast¹⁶
- 538th Guards Anti-Aircraft Missile Regiment, В/ч 51383 — Naro-Fominsk, Moscow Oblast¹⁷

47th Tank Division (Established on the basis of the 6th Tank Brigade in December 2021), В/ч 64238 — Mulino, Nizhny Novgorod Oblast¹⁸

- 26th Tank Regiment, В/ч UNK — Mulino, Nizhny Novgorod¹⁹

- 7th Reconnaissance Battalion, В/ч UNK — UNK basing²⁰
- [Likely Unidentified Artillery Regiment]
- [Likely Unidentified Anti-Aircraft Missile Brigade]

Subordinate to Army HQ

- 27th Motorized Rifle Brigade, В/ч 61899 — Mosrentgen, Moscow City²¹
- 96th Reconnaissance Brigade, В/ч 52634 — Nizhny Novgorod, Nizhny Novgorod Oblast²²
- 288th Artillery Brigade, В/ч 30683 — Mulino, Nizhny Novgorod Oblast²³
- 112th Missile Brigade, В/ч 03333 — Shuya, Ivanovo Oblast²⁴

6th Combined Arms Army, В/ч 31807 — Agalatovo, Leningrad Oblast²⁵

Subordinate to Army HQ

- 138th Motorized Rifle Brigade, В/ч 02511 — Kamenka, Leningrad Oblast²⁶
- 25th Motorized Rifle Brigade, В/ч 29760 — Luga, Leningrad Oblast²⁷
- 9th Artillery Brigade, В/ч 02561 — Luga, Leningrad Oblast²⁸
- 26th Missile Brigade, В/ч 54006 — Luga, Leningrad Oblast²⁹
- 5th Anti-Aircraft Missile Brigade, В/ч 74429 — Gorlovo, St. Petersburg City³⁰

20th Guards Combined Arms Army, В/ч 89425 — Voronezh, Voronezh Oblast³¹

3rd Motorized Rifle Division, В/ч 54046 — Boguchar, Voronezh Oblast³²

- 752nd Motorized Rifle Regiment, В/ч 34670 — Valuyki, Belgorod Oblast³³
- 252nd Motorized Rifle Regiment, В/ч 91711 — Boguchar, Voronezh Oblast³⁴
- 237th Guards Tank Regiment, В/ч 91726 — Valuyki and Soloti, Belgorod Oblast³⁵
- 84th Reconnaissance Battalion, В/ч 22263 — Valuyki, Belgorod Oblast³⁶
- 99th Self-Propelled Artillery Regiment, В/ч 91727 — Boguchar, Voronezh Oblast³⁷

- 159th Separate Anti-Tank Battalion, В/ч 81989 — Boguchar, Voronezh Oblast³⁸
- 1143rd Separate Anti-Aircraft Missile Battalion, В/ч 48422 — Nizhny Novgorod, Nizhny Novgorod Oblast³⁹

144th Motorized Rifle Division, В/ч 23060 — Yelnya, Smolensk Oblast⁴⁰

- 254th Guards Motorized Rifle Regiment, В/ч 91704 — Zaimishche village, Klinty, Bryansk Oblast⁴¹
- 488th Guards Motorized Rifle Regiment, В/ч 12721 — Klinty, Bryansk Oblast⁴²
- 59th Guards Tank Regiment, В/ч 94018 — Yelnya, Smolensk Oblast⁴³
- 148th Reconnaissance Battalion, В/ч 23872 — Smolensk, Smolensk Oblast⁴⁴
- 856th Guards Self-Propelled Artillery Regiment, В/ч 23857 — Pochep, Bryansk Oblast⁴⁵
- 1259th Separate Anti-Tank Artillery Battalion, В/ч UNK — Yelnya, Smolensk Oblast⁴⁶
- 673rd Separate Anti-Aircraft Missile Battalion, В/ч 53821 — Smolensk, Smolensk Oblast⁴⁷

Subordinate to Army HQ

- 236th Guards Artillery Brigade, В/ч 53195 — Kolomna, Moscow Oblast⁴⁸
- 448th Missile Brigade, В/ч 35535 — Kursk, Kursk Oblast⁴⁹
- 53rd Guards Anti-Aircraft Missile Brigade, В/ч 32406 — Marshal Zhukov village, Kursk Oblast⁵⁰

Baltic Sea Fleet, В/ч 51280 — Kaliningrad and Gusev, Kaliningrad Oblast⁵¹

11th Army Corps (Established in 2016), В/ч 54259 — Gusev, Kaliningrad Oblast⁵²

18th Guards Motorized Rifle Division (Established December 2020 on the basis of the 79th Separate Guards Motorized Rifle Brigade), В/ч UNK — Gusev, Kaliningrad Oblast⁵³

- 275th Motorized Rifle Regiment (Newly established, presented with formal banners in April 2021), В/ч UNK—Gusev, Kaliningrad Oblast⁵⁴
- 280th Motorized Rifle Regiment (Newly established, presented with formal banners

in April 2021), В/ч UNK — Gusev, Kaliningrad Oblast⁵⁵

- 79th Guards Motorized Rifle Regiment, В/ч 90151 — Gusev, Kaliningrad Oblast⁵⁶
- 11th Tank Regiment (Established late 2018 on the basis of the 11th Separate Tank Battalion), В/ч 41611 — Gusev, Kaliningrad Oblast⁵⁷
- 20th Separate Reconnaissance Battalion, В/ч 12563 — Sovetsk, Kaliningrad Oblast⁵⁸
- 22nd Guards Anti-Aircraft Missile Regiment, В/ч UNK — Kaliningrad, Kaliningrad Oblast⁵⁹

Subordinate to Corps HQ

- 7th Guards Motorized Rifle Regiment (a Russian media outlet reported in 2016 that the 7th Regiment would be reorganized into a brigade, but ISW has not observed further confirmation of this change), В/ч 06414 — Kaliningrad, Kaliningrad Oblast⁶⁰
- 336th Naval Infantry Brigade, В/ч 06017 — Baltiysk, Kaliningrad Oblast⁶¹
- 561st Maritime Reconnaissance Point (essentially a naval spetsnaz battalion), В/ч 10617 — Parusnoye, Kaliningrad Oblast⁶²
- 244th Artillery Brigade, В/ч 41603 — Kaliningrad, Kaliningrad Oblast⁶³
- 152nd Missile Brigade, В/ч 54229 — Chernyakhovsk, Kaliningrad Oblast⁶⁴
- 27th Coastal Missile Brigade, В/ч 39108 — Donskoye, Kaliningrad Oblast⁶⁵

District-level units

Operative Group of the Russian Armed Forces in Transnistria, Moldova, В/ч 13962 — Tiraspol, Moldova⁶⁶

- 82nd Motorized Rifle Battalion, В/ч 74273 — Bender and Tiraspol, Moldova⁶⁷
- 113th Motorized Rifle Battalion, В/ч 22137 — Tiraspol, Moldova⁶⁸
- 540th Command Battalion, В/ч 09353 — Tiraspol, Moldova⁶⁹

45th Heavy Artillery Brigade, В/ч 31969 — Tambov, Tambov Oblast⁷⁰

79th Guards Rocket Artillery Brigade, В/ч 53959 — Tver, Tver Oblast⁷¹

202nd Anti-Aircraft Missile Brigade, В/ч 43034 — Naro-Fominsk, Moscow Oblast⁷²

27th Separate Guards Radiation, Chemical, and Biological Protection Brigade, В/ч 11262 — Kursk, Kursk Oblast⁷³

1st Guards Engineer-Sapper Brigade, В/ч 11105 — Murom, Vladimir Oblast⁷⁴

45th Separate Guards Engineering Brigade, В/ч 11361 — Nakhabino, Moscow Oblast⁷⁵

Southern Military District

8th Guards Combined Arms Army, В/ч 61877 — Novocheerkassk, Rostov Oblast⁷⁶

150th Motorized Rifle Division, В/ч 22179 — Novocheerkassk, Rostov Oblast⁷⁷

- 102nd Motorized Rifle Regiment, В/ч 91706 — Persianovskiy, Rostov Oblast⁷⁸
- 103rd Motorized Rifle Regiment, В/ч 91708 — Rostov-on-Don, Rostov Oblast⁷⁹
- 68th Tank Regiment, В/ч 91714 — Persianovskiy, Rostov Oblast⁸⁰
- 163rd Tank Regiment, В/ч 84839 — Persianovskiy, Rostov Oblast⁸¹
- 174th Reconnaissance Battalion, В/ч 22265 — Persianovskiy, Rostov Oblast⁸²
- 381st Self-Propelled Artillery Regiment, В/ч 24390 — Kuzminka, Rostov Oblast⁸³
- 224th Separate Anti-Tank Artillery Battalion, В/ч UNK — Kuzminka, Rostov Oblast⁸⁴
- 933rd Anti-Aircraft Missile Regiment, В/ч 15269 — Millerovo, Rostov Oblast⁸⁵

20th Guards Motorized Rifle Division (Established on the basis of the 20th Guards Motorized Rifle Brigade in December 2021), В/ч 58550 — Volgograd, Volgograd Oblast⁸⁶

- 255th Motorized Rifle Regiment, В/ч 34605 — Volgograd, Volgograd Oblast⁸⁷
- 33rd Motorized Rifle Regiment, В/ч UNK — Kamyshin, Volgograd Oblast⁸⁸
- 944th Guards Self-Propelled Artillery Regiment, В/ч 21511 — Latoshinka, Volgograd Oblast⁸⁹

• 487th Separate Anti-Tank Battalion, В/ч UNK — Volgograd, Volgograd Oblast⁹⁰

• 358th Guards Anti-Aircraft Missile Regiment, В/ч 26006 — Kamyshin, Volgograd Oblast⁹¹

Subordinate to Army HQ

- 238th Artillery Brigade, В/ч UNK — Korenovsk, Krasnodar Krai⁹²
- 47th Missile Brigade, В/ч 33166 — Dyadkovskaya village, Krasnodar Krai⁹³
- 78th Anti-Aircraft Missile Brigade, В/ч UNK — UNK town, Rostov Oblast⁹⁴

49th Combined Arms Army, В/ч 35181 — Stavropol, Stavropol Krai⁹⁵

Subordinate to Army HQ

- 205th Motorized Rifle Brigade, В/ч 74814 — Budyonovsk, Stavropol Krai⁹⁶
- 34th Motorized Rifle Brigade (Mountain), В/ч 01485 — Storozhevaya, Karachay-Cherkessia⁹⁷
- 7th Military Base (Brigade strength), В/ч, 09332 — Gudauta, Abkhazia⁹⁸
- 19th Separate Special Forces Company, В/ч 82760 — Stavropol, Stavropol Krai⁹⁹
- 227th Artillery Brigade, В/ч 13714 — Maykop, Adgyea Republic¹⁰⁰
- 1st Missile Brigade, В/ч 31853 — Molkino, Krasnodar Krai¹⁰¹
- 90th Anti-Aircraft Missile Brigade, В/ч 54821 — Afipsky, Krasnodar Krai¹⁰²

58th Combined Arms Army, В/ч 47084 — Vladikavkaz, North Ossetia-Alania Republic¹⁰³

42nd Motorized Rifle Division, В/ч 27777 — Grozny, Chechnya¹⁰⁴

- 70th Guards Motorized Rifle Regiment, В/ч 71718 — Shali, Chechnya¹⁰⁵
- 71st Guards Motorized Rifle Regiment, В/ч 16544 — Kalinovskaya, Chechnya¹⁰⁶
- 291st Guards Motorized Rifle Regiment, В/ч 65384 — Borzoy, Chechnya¹⁰⁷
- 78th Special Purpose Motorized Regiment “Sever-Akhmat” (Newly formed in September 2022 by Chechen Republic Head Ramzan Kadyrov and reportedly subordinated to the 42nd Motorized Rifle

Division), В/ч 77192 — Sernovodskoye, Chechnya¹⁰⁸

- 417th Separate Reconnaissance Battalion, В/ч 13242 — Khankala, Chechnya¹⁰⁹
- 50th Self-Propelled Artillery Regiment, В/ч 53185 — Shali, Chechnya¹¹⁰
- 150th Separate Anti-Tank Artillery Battalion, В/ч 24566 — Grozny, Chechnya¹¹¹
- 245th Separate Anti-Aircraft Missile Battalion, В/ч 81510 — Grozny, Chechnya¹¹²

19th Motorized Rifle Division, В/ч 20634 — Vladikavkaz, Republic of North Ossetia-Alania¹¹³

- 429th Motorized Rifle Regiment, В/ч 01860 — Sputnik, Vladikavkaz, Republic of North Ossetia-Alania¹¹⁴
- 503rd Motorized Rifle Regiment, В/ч 75394 — Vladikavkaz, Republic of North Ossetia-Alania¹¹⁵
- [Likely Unidentified Artillery Regiment]
- [Likely Unidentified Anti-Aircraft Missile Regiment]

Subordinate to Army HQ

- 136th Guards Motorized Rifle Brigade, В/ч 63354 — Buynaksk, Dagestan¹¹⁶
- 4th Guards Base, В/ч 66431 — Tskhinvali, South Ossetia¹¹⁷
- 100th Reconnaissance Brigade, В/ч 23511 — Mozdok, Republic of North Ossetia-Alania¹¹⁸
- 291st Artillery Brigade, В/ч 64670 — Troitskaya, Republic of Ingushetia¹¹⁹
- 12th Missile Brigade, В/ч 25788 — Mozdok, Republic of North Ossetia-Alania¹²⁰

Black Sea Fleet, В/ч UNK — Sevastopol, occupied Crimea¹²¹

22nd Army Corps, В/ч 73954 — Simferopol, occupied Crimea¹²²

- 126th Coastal Defense Brigade, В/ч 12676 — Perevalne, occupied Crimea¹²³
- 127th Reconnaissance Brigade, В/ч 67606 — Sevastopol, occupied Crimea¹²⁴
- 8th Artillery Regiment, В/ч 87714 — Perevalne, occupied Crimea¹²⁵
- 15th Coastal Missile Brigade, В/ч UNK — Sevastopol, occupied Crimea¹²⁶

Subordinate to Fleet HQ

- 810th Naval Infantry Brigade, В/ч 13140 — Sevastopol, occupied Crimea¹²⁷
- 388th Maritime Recon Point (essentially a naval spetsnaz battalion), В/ч 43071 — Sevastopol, occupied Crimea¹²⁸
- 854th Separate Coastal Missile Regiment, В/ч UNK — Sevastopol, occupied Crimea¹²⁹
- 11th Coastal Missile Brigade, В/ч 00916 — Utash and Anapa, Krasnodar Krai¹³⁰

District-level units

Caspian Flotilla, В/ч 62780 — Kaspiysk, Dagestan¹³¹

- 177th Naval Infantry Regiment, В/ч UNK — Kaspiysk, Dagestan¹³²
- 51st Separate Coastal Missile Battalion, В/ч UNK — Kaspiysk, Dagestan¹³³

102nd Military Base (Exact composition unknown but presumed), В/ч 04436 — Gyumri, Armenia¹³⁴

- [3 Unidentified motorized rifle battalions]
- [1 Unidentified tank battalion]
- [2 Unidentified self-propelled artillery battalions]
- [1 Unidentified rocket artillery battalion]
- [1 Unidentified anti-tank artillery battalion]
- [1 Unidentified anti-aircraft missile battalion]
- [1 Unidentified anti-aircraft missile and artillery battalion]
- 988th Anti-aircraft Missile Regiment, В/ч 81594 — Gyumri, Armenia¹³⁵

439th Guards Rocket Artillery Brigade, В/ч 48315 — Znamensk, Astrakhan Oblast¹³⁶

77th Anti-Aircraft Missile Brigade, В/ч 33742 — Korenovsk, Krasnodar Krai¹³⁷

11th Separate Guards Engineering Brigade, В/ч 45767 — Kamensk-Shakhtinsky, Rostov Oblast¹³⁸

28th Separate Radiation, Chemical, and Biological Protection Brigade, В/ч 65363 — Kamyshin, Volgograd Oblast¹³⁹

Central Military District

41st Combined Arms Army, В/Ч 64128 — Novosibirsk, Novosibirsk Oblast¹⁴⁰

90th Guards Tank Division, В/Ч 86274 — Chebarkul, Chelyabinsk Oblast¹⁴¹

- 239th Tank Regiment, В/Ч 89547 — Chebarkul, Chelyabinsk Oblast¹⁴²
- 6th Guards Tank Regiment, В/Ч 93992 — Chebarkul, Chelyabinsk Oblast¹⁴³
- 80th Tank Regiment, В/Ч 87441 — Chebarkul, Chelyabinsk Oblast¹⁴⁴
- 228th Motorized Rifle Regiment, В/Ч 22316 — Yekaterinburg, Sverdlovsk Oblast¹⁴⁵
- 30th Reconnaissance Battalion, В/Ч 17654 — Chebarkul, Chelyabinsk Oblast¹⁴⁶
- 400th Self-Propelled Artillery Regiment, В/Ч 15871 — Chebarkul, Chelyabinsk Oblast¹⁴⁷

Subordinate to Army HQ

- 35th Guards Motorized Rifle Brigade, В/Ч 41659 — Aleysk, Altai Krai¹⁴⁸
- 74th Guards Motorized Rifle Brigade, В/Ч 21005 — Yurga, Kemerovo Oblast¹⁴⁹
- 55th Motorized Rifle Brigade (Mountain), В/Ч 55115 — Kyzyl, Tuva Republic¹⁵⁰
- 120th Artillery Brigade, В/Ч 59361 — Yurga, Kemerovo Oblast¹⁵¹
- 199th Missile Brigade, В/Ч 49547 — Yelanskiy, Sverdlovsk Oblast¹⁵²

2nd Guards Combined Arms Army, В/Ч 22223 — Samara, Samara Oblast¹⁵³

Subordinate to Army HQ

- 30th Motorized Rifle Brigade, В/Ч 45863 — Roshchinsky, Samara Oblast¹⁵⁴
- 15th Motorized Rifle Brigade, В/Ч 90600 — Roshchinsky, Samara Oblast¹⁵⁵
- 21st Guards Motorized Rifle Brigade, В/Ч 12128 — Totskoye, Orenburg Oblast¹⁵⁶
- 385th Artillery Brigade, В/Ч 32755 — Totskoye, Orenburg Oblast¹⁵⁷
- 950th Rocket Artillery Regiment, В/Ч 92190 — Totskoye, Orenburg Oblast¹⁵⁸
- 92nd Missile Brigade, В/Ч 30785 — Totskoye, Orenburg Oblast¹⁵⁹

- 297th Anti-Aircraft Missile Brigade, В/Ч 02030 — Leonidovka, Penza Oblast¹⁶⁰

District-level units

201st Military Base, В/Ч 01162 — Dushanbe, Tajikistan¹⁶¹

- 92nd Motorized Rifle Regiment, В/Ч 31691 — Dushanbe, Tajikistan¹⁶²
- [Unidentified Separate Tank Battalion] — Dushanbe, Tajikistan
- [Unidentified Reconnaissance Battalion] — Dushanbe, Tajikistan
- [Unidentified Rocket Artillery Battalion] — Dushanbe, Tajikistan
- 232nd Guards Rocket Artillery Brigade, В/Ч 31643 — Cherbakul, Chelyabinsk Oblast¹⁶³
- 28th Anti-Aircraft Missile Brigade, В/Ч 71316 — Mirny, Kirov Oblast¹⁶⁴
- 1st Mobile Radiation, Chemical, and Biological Protection Brigade, В/Ч 71432 — Shikhany, Saratov Oblast¹⁶⁵
- 29th Separate Radiation, Chemical, and Biological Protection Brigade, В/Ч 34081 — Yekaterinburg, Sverdlovsk Oblast¹⁶⁶
- 12th Separate Guards Engineering Brigade, В/Ч 63494 — Alkino-2, Bashkortostan¹⁶⁷

Eastern Military District

5th Combined Arms Army, В/Ч 06426 — Ussuriysk, Primorsky Krai¹⁶⁸

127th Motorized Rifle Division (Established in December 2018 on the basis of the 59th Motorized Rifle Brigade), В/Ч 44980 — Sergeyevka, Primorsky Krai¹⁶⁹

- 394th Motorized Rifle Regiment, В/Ч 25573 — Sergeyevka, Primorsky Krai¹⁷⁰
- 143rd Motorized Rifle Regiment, В/Ч 21634 — Sergeyevka, Primorsky Krai¹⁷¹
- 114th Motorized Rifle Regiment, В/Ч 24776 — Ussuriysk, Primorsky Krai¹⁷²
- 218th Tank Regiment, В/Ч 82588 — Sergeyevka, Primorsky Krai¹⁷³
- 872nd Self-Propelled Artillery Regiment, В/Ч 75234 — Sergeyevka, Primorsky Krai¹⁷⁴
- 1171st Anti-Aircraft Missile Regiment, В/Ч 65484 — Ussuriysk, Primorsky Krai¹⁷⁵

Subordinate to Army HQ

- 57th Guards Motorized Rifle Brigade, В/ч 46102 — Bikin, Khabarovsk Krai¹⁷⁶
- 305th Artillery Brigade, В/ч 39255 — Us-suriysk, Primorsky Krai¹⁷⁷
- 20th Missile Brigade, В/ч 92088 — Spassk-Dalny, Primorsky Krai¹⁷⁸

35th Combined Arms Army, В/ч 02492 — Belogorsk, Amur Oblast¹⁷⁹

Subordinate to Army HQ

- 64th Motorized Rifle Brigade, В/ч 51460 — Knyaze-Volkonskoye, Khabarovsk Krai¹⁸⁰
- 38th Guards Motorized Rifle Brigade, В/ч 21720 — Ekaterinoslavka, Amur Oblast¹⁸¹
- 69th Covering Brigade (a strictly defensive brigade on the Chinese border), В/ч 61424 — Babstovo, Jewish Autonomous Oblast¹⁸²
- 165th Artillery Brigade, В/ч 02901 — Belogorsk, Amur Oblast¹⁸³
- 107th Missile Brigade, В/ч 47062 — Biro-bidzhan, Jewish Autonomous Oblast¹⁸⁴
- 71st Anti-Aircraft Missile Brigade, В/ч 01879 — Belogorsk, Amur Oblast¹⁸⁵

36th Combined Arms Army, В/ч 05776 — Ulan-Ude, Republic of Buryatia¹⁸⁶

Subordinate to Army HQ

- 37th Guards Motorized Rifle Brigade, В/ч 69647 — Kyakhta, Republic of Buryatia¹⁸⁷
- 5th Guards Tank Brigade, В/ч 46108 — Divizionnaya station, Republic of Buryatia¹⁸⁸
- 30th Artillery Brigade, В/ч 62048 — Divizionnaya and Taltsy stations, Republic of Buryatia¹⁸⁹
- 103rd Missile Brigade, В/ч 47130 — Divizionnaya station, Republic of Buryatia¹⁹⁰
- 35th Guards Anti-Aircraft Missile Brigade, В/ч 34696 — Ulan-Ude, Republic of Buryatia¹⁹¹

29th Combined Arms Army, В/ч 32853 — Chita, Zabaykalsky Krai¹⁹²

Subordinate to Army HQ

- 36th Guards Motorized Rifle Brigade, В/ч 06705 — Borzya, Zabaykalsky Krai¹⁹³
- 200th Artillery Brigade, В/ч 48271 — Gornyy, Zabaykalsky Krai¹⁹⁴
- 3rd Missile Brigade, В/ч 33558 — Gornyy, Zabaykalsky Krai¹⁹⁵
- 140th Anti-Aircraft Missile Brigade, В/ч 32390 — Domna, Zabaykalsky Krai¹⁹⁶

Pacific Fleet, В/ч 62665 — Vladivostok, Primorsky Krai¹⁹⁷

Subordinate to Fleet HQ

- 155th Naval Infantry Brigade, В/ч 30926 — Vladivostok, Primorsky Krai¹⁹⁸
- 40th Naval Infantry Brigade, В/ч 10103 — Petropavlovsk-Kamchatsky, Kamchatka Krai¹⁹⁹
- 42nd Maritime Reconnaissance Point (essentially a naval spetsnaz battalion), В/ч 59190 — Russky Island, Primorsky Krai²⁰⁰
- 72nd Coastal Missile Brigade, В/ч 15118 — Smolyaninovo, Primorsky Krai²⁰¹
- 520th Coastal Missile Brigade, В/ч 30973 — Anglichanka, Kamchatka Krai²⁰²
- 75th Coastal Missile Brigade (Newly formed in December 2020), В/ч UNK — Sakhalin and Kuril Islands²⁰³

68th Army Corps, В/ч UNK — Yuzhno-Sakhalinsk, Sakhalin and Kuril Islands²⁰⁴

18th Machine Gun Artillery Division (an under-resourced and insufficiently mechanized unit intended to defend the Kuril Islands against Japan), В/ч 05812 — Goryachiye Klyuchi, Sakhalin Oblast²⁰⁵

- 46th Machine Gun Artillery Regiment, В/ч 71435 — Lagunnoye, Kunashir/Kunashiri Island, Sakhalin Oblast²⁰⁶
- 49th Machine Gun Artillery Regiment, В/ч 71439 — Goryachiye Klyuchi, Sakhalin Oblast²⁰⁷
- [Unidentified Rocket Artillery Battery], В/ч UNK — Kunashir/Kunashiri Island, Sakhalin Oblast

Corps-level units

- 39th Motorized Rifle Brigade, В/ч 35390 — Yuzhno-Sakhalinsk, Sakhalin Oblast²⁰⁸

- 312th Separate Rocket Artillery Battalion, В/ч UNK — Dachnoe, Sakhalin Oblast²⁰⁹

District-level units

- 338th Guards Rocket Artillery Brigade, В/ч 57367 — Ussuriysk, Krasnodar Krai²¹⁰
- 38th Anti-Aircraft Missile Brigade (Newly formed in January 2020), В/ч 47836 — Ptichnik, Jewish Autonomous Oblast²¹¹
- 16th Radiation, Chemical, and Biological Protection Brigade, В/ч 07059 — Lesozavodsk, Primorsky Krai²¹²
- 14th Separate Guards Engineering Brigade, В/ч 30763 — Vyatskoye, Khabarovsk Krai²¹³

Northern Fleet and Arctic Joint Strategic Command

Northern Fleet, В/ч 20546 — Severomorsk, Murmansk Oblast²¹⁴

14th Army Corps, В/ч UNK — Severomorsk, Murmansk Oblast²¹⁵

- 200th Motorized Rifle Brigade, В/ч 08275 — Luostari, Pechenga and Korzunovo, Murmansk Oblast²¹⁶
- 80th Arctic Motorized Rifle Brigade, В/ч 34667 — Alakurtii, Murmansk Oblast²¹⁷

District-level units — Severomorsk, Murmansk Oblast

- 61st Naval Infantry Brigade, В/ч 38643 — Sputnik, Murmansk Oblast²¹⁸
- 420th Maritime Reconnaissance Point (essentially a naval spetsnaz battalion), В/ч 40145 — Polyarny, Murmansk Oblast²¹⁹
- 536th Coastal Missile Brigade, В/ч 10544 — Olenya Guba, Murmansk Oblast²²⁰
- 63rd Separate Marine Engineering Regiment, В/ч 36085 — Severomorsk, Murmansk Oblast²²¹

Russian Airborne Forces (VDV)

7th Guards Mountain Air Assault Division, В/ч 61756 — Novorossiysk, Krasnodar Krai²²²

- 56th Guards Air Assault Regiment, В/ч UNK — Feodosia, occupied Crimea²²³

- 108th Guards Air Assault Regiment, В/ч 42091 — Novorossiysk, Krasnodar Krai²²⁴
- 247th Guards Air Assault Regiment, В/ч 54801 — Stavropol, Stavropol Krai²²⁵
- 171st Separate Air Assault Battalion, В/ч UNK — Feodosia, occupied Crimea²²⁶
- 104th Separate Tank Battalion, В/ч UNK — Novorossiysk, Krasnodar Krai²²⁷
- 162nd Separate Reconnaissance Battalion, В/ч 54377 — Novorossiysk, Krasnodar Krai²²⁸
- 1141st Artillery Regiment, В/ч 40515 — Anapa, Krasnodar Krai²²⁹
- 1537th Anti-Aircraft Missile Regiment, В/ч 26345 — Novorossiysk, Krasnodar Krai²³⁰
- 3rd Guards Anti-Aircraft Missile Regiment, В/ч 94021 — Novorossiysk, Krasnodar Krai²³¹

76th Guards Air Assault Division, В/ч 07264 — Pskov, Pskov Oblast²³²

- 104th Guards Air Assault Regiment, В/ч 32515 — Cherekha, Pskov Oblast²³³
- 234th Guards Air Assault Regiment, В/ч 74268 — Pskov, Pskov Oblast²³⁴
- 237th Guards Air Assault Regiment, В/ч 12865 — Pskov, Pskov Oblast²³⁵
- 124th Separate Tank Battalion, В/ч UNK — Pskov, Pskov Oblast²³⁶
- 175th Separate Reconnaissance Battalion, В/ч 54399 — Pskov, Pskov Oblast²³⁷
- 1140th Artillery Regiment, В/ч 45377 — Pskov, Pskov Oblast²³⁸
- 4th Guards Anti-Aircraft Missile Regiment, В/ч UNK — Pskov, Pskov Oblast²³⁹

98th Guards Airborne Division, В/ч 65451 — Ivanovo, Ivanovo Oblast²⁴⁰

- 217th Guards Airborne Regiment, В/ч 62295 — Ivanovo, Ivanovo Oblast²⁴¹
- 331st Guards Airborne Regiment, В/ч 71211 — Kostroma, Kostroma Oblast²⁴²
- 215th Separate Reconnaissance Battalion, В/ч 65391 — Ivanovo, Ivanovo Oblast²⁴³
- 1065th Artillery Regiment, В/ч 62297 — Kostroma, Kostroma Oblast²⁴⁴

- 5th Guards Anti-Aircraft Missile Regiment, В/ч 65376 — Ivanovo, Ivanovo Oblast²⁴⁵

106th Guards Airborne Division, В/ч 55599 — Tula, Tula Oblast²⁴⁶

- 51st Guards Airborne Regiment, В/ч 33842 — Tula, Tula Oblast²⁴⁷
- 137th Guards Airborne Regiment, В/ч 41450 — Ryazan, Ryazan Oblast²⁴⁸
- 173rd Separate Reconnaissance Battalion, В/ч 54392 — Tula, Tula Oblast²⁴⁹
- 1182nd Artillery Regiment, В/ч 93723 — Naro-Fominsk, Moscow Oblast²⁵⁰
- 1st Guards Anti-Aircraft Missile Regiment, В/ч 71298 — Naro-Fominsk, Moscow Oblast²⁵¹
- [Unidentified Separate Tank Battalion], В/ч UNK — Location UNK but likely Tula Oblast

Independent brigades not subordinate to a division

- 11th Separate Guards Air Assault Brigade, В/ч 32364 — Ulan-Ude, Republic of Buryatia²⁵²
- 31st Separate Guards Air Assault Brigade, В/ч 73612 — Ulyanovsk, Ulyanovsk Oblast²⁵³
- 83rd Separate Guards Air Assault Brigade, В/ч 71289 — Ussuriysk, Primorsky Krai²⁵⁴
- 45th Guards Spetsnaz Brigade (VDV unit which operates as Spetsnaz formation), В/ч 28337 — Kubinka, Moscow Oblast²⁵⁵

GRU Spetsnaz and Special Operations Forces

Spetsnaz Brigades (subordinate to the General Staff's Main Intelligence Directorate)

- 2nd Guards Special Purpose Brigade, В/ч 64044 — Pskov, Pskov Oblast²⁵⁶
- 3rd Guards Special Purpose Brigade, В/ч 21208 — Tolyatti, Samara Oblast²⁵⁷
- 10th Guards Special Purpose Brigade, В/ч 51532 — Molkino, Krasnodar Krai²⁵⁸
- 14th Guards Special Purpose Brigade, В/ч 74854 — Khabarovsk, Khabarovsk Krai²⁵⁹
- 16th Guards Special Purpose Brigade, В/ч 54607 — Tambov, Tambov Oblast²⁶⁰
- 22nd Guards Special Purpose Brigade, В/ч 11659 — Stepnoy, Rostov Oblast²⁶¹
- 24th Guards Special Purpose Brigade, В/ч 55433 — Novosibirsk, Novosibirsk Oblast²⁶²
- 25th Guards Special Purpose Regiment, В/ч 05525 — Stavropol, Stavropol Krai²⁶³

Special Operations Command

- KSSO forces, formed around the core of the 346th Guards Special Purpose Brigade, В/ч UNK — Kubinka, Moscow Oblast

RUSSIAN REGULAR GROUND FORCES ORDER OF BATTLE



Interactive Map

*Noel Mikkelsen and George Barros with Thomas Bergeron,
Daniel Mealie, and Mitchell Belcher*



storymaps.arcgis.com/stories/6d9825cbafcd4cbf91cb6ce80d9e3f0f

Russian Military Districts



*Map by Noel Mikkelsen and George Barros
© 2023 Institute for the Study of War*



Central Military District

Eastern Military District

Russian Army Headquarters

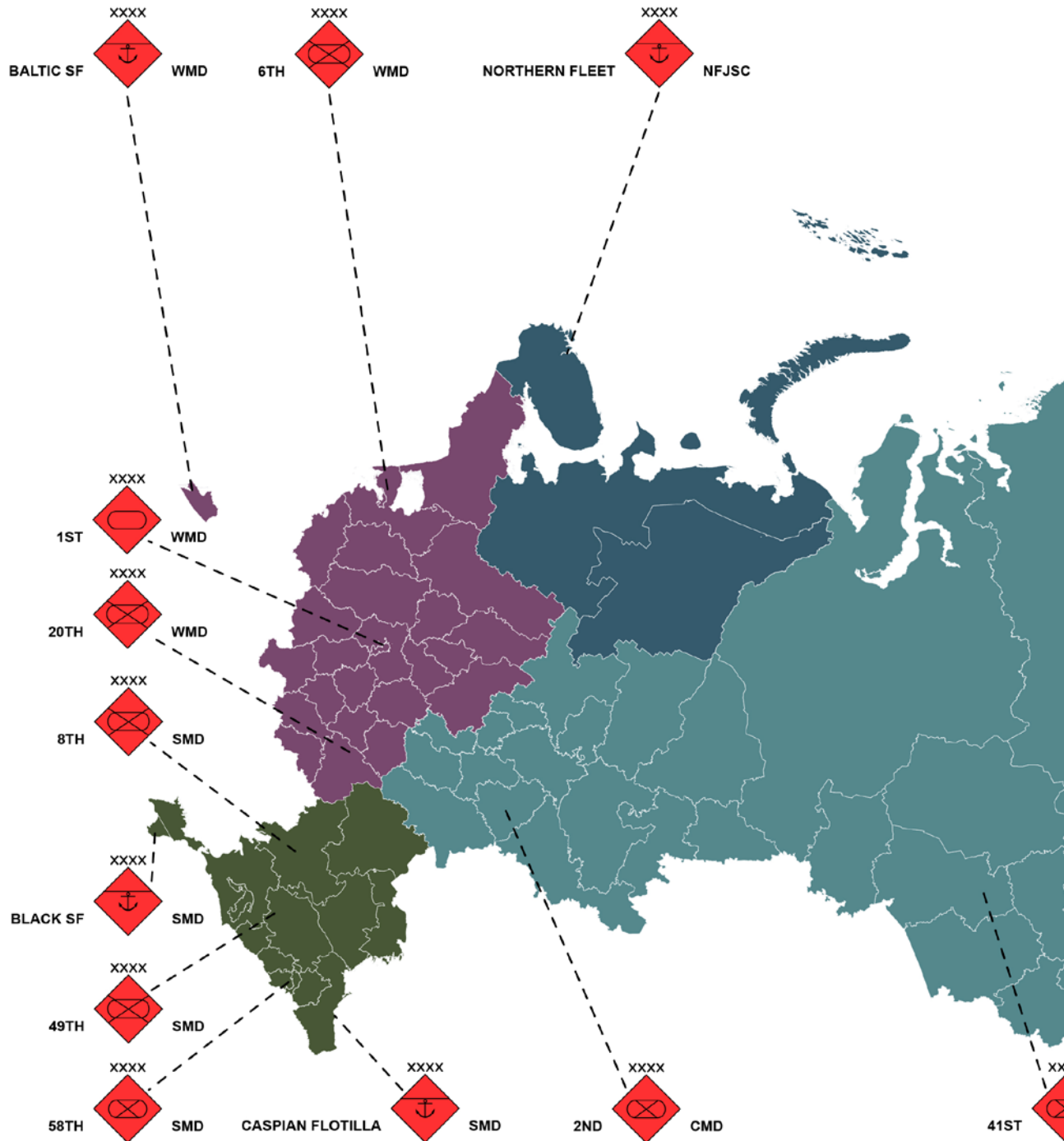

Map by Noel Mikkelsen and George Barros
© 2023 Institute for the Study of War

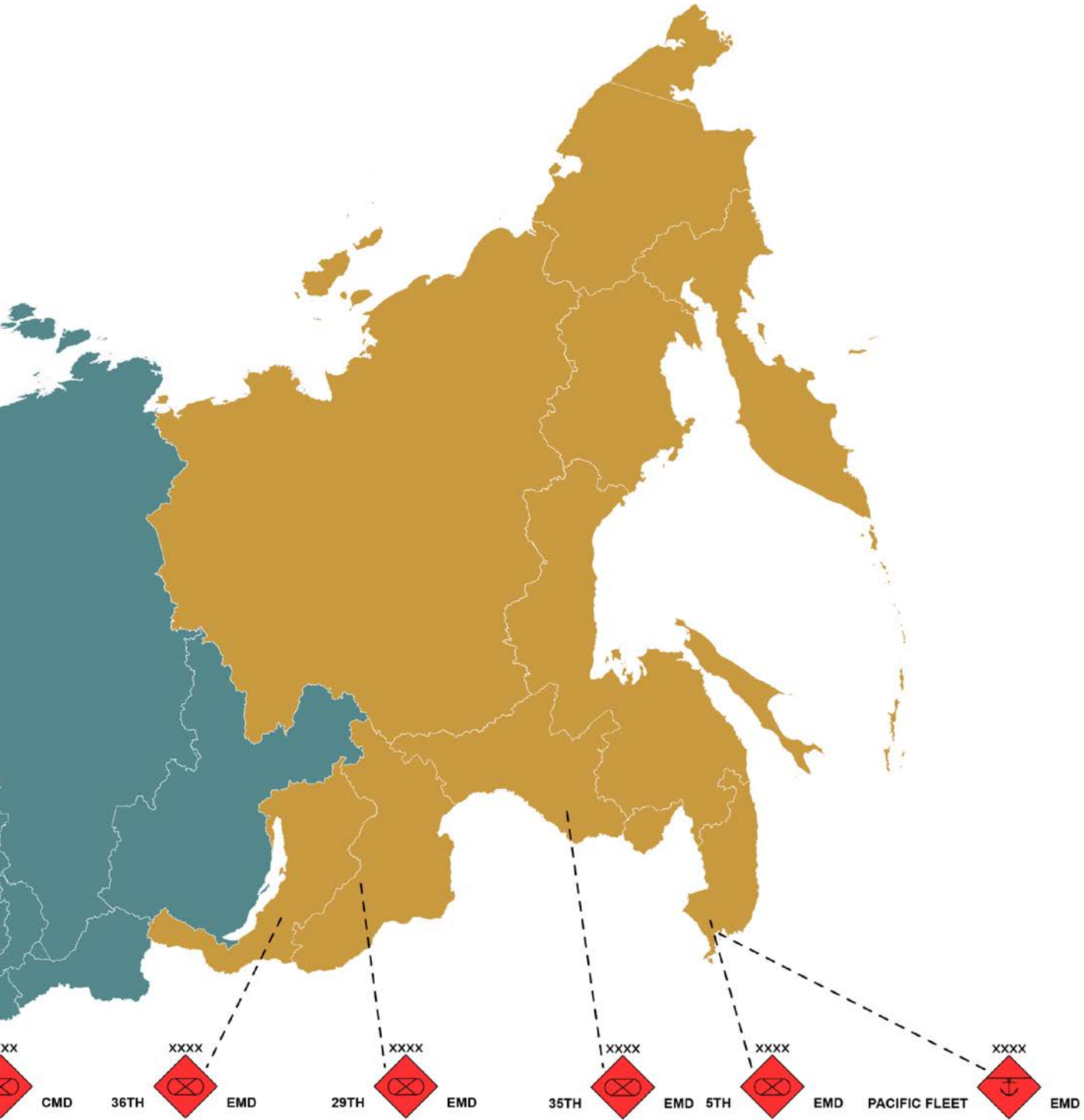

Western Military District

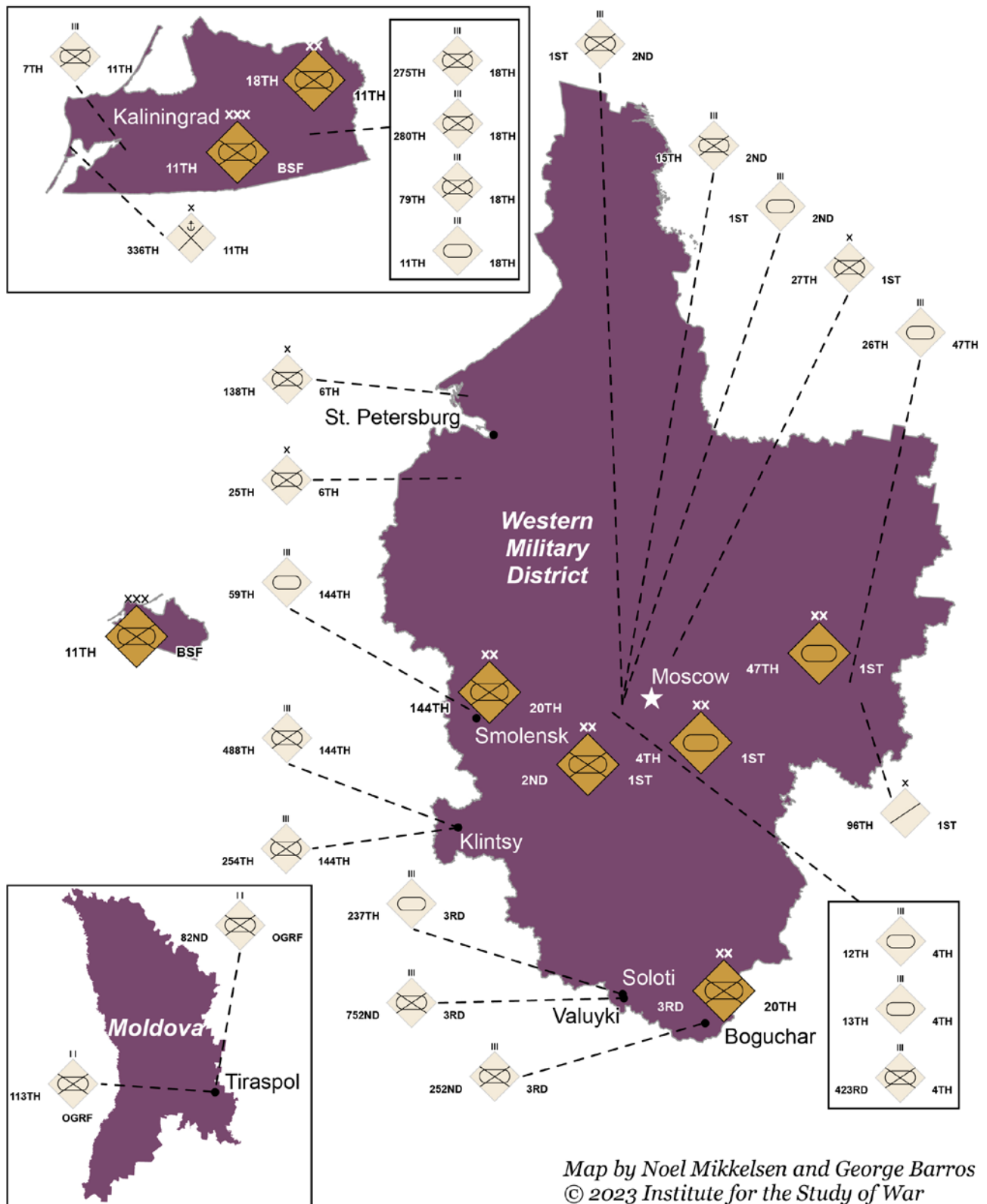

Map by Noel Mikkelsen and George Barros
© 2023 Institute for the Study of War

Southern Military District

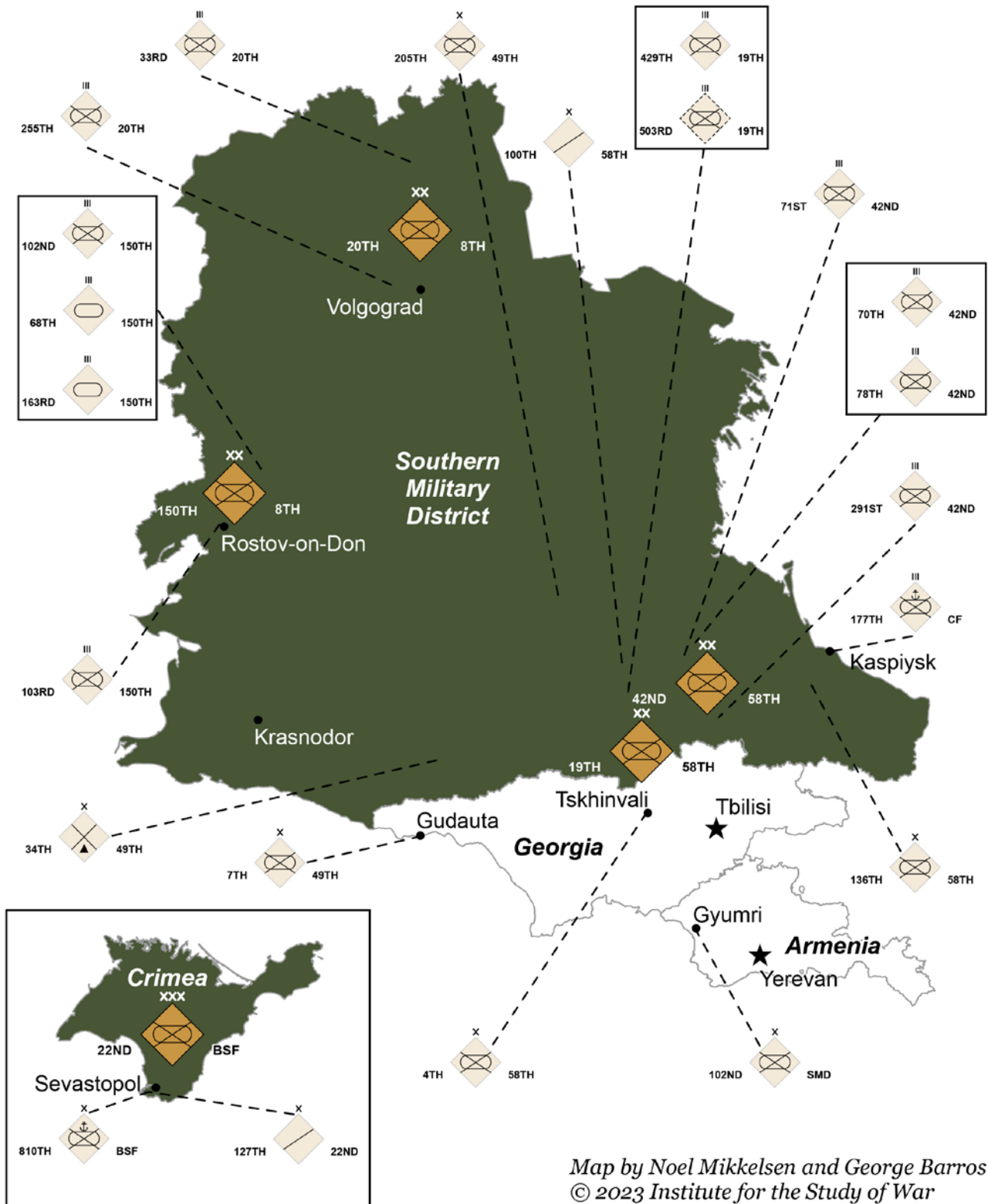

Map by Noel Mikkelsen and George Barros
© 2023 Institute for the Study of War

Russian Order of Battle

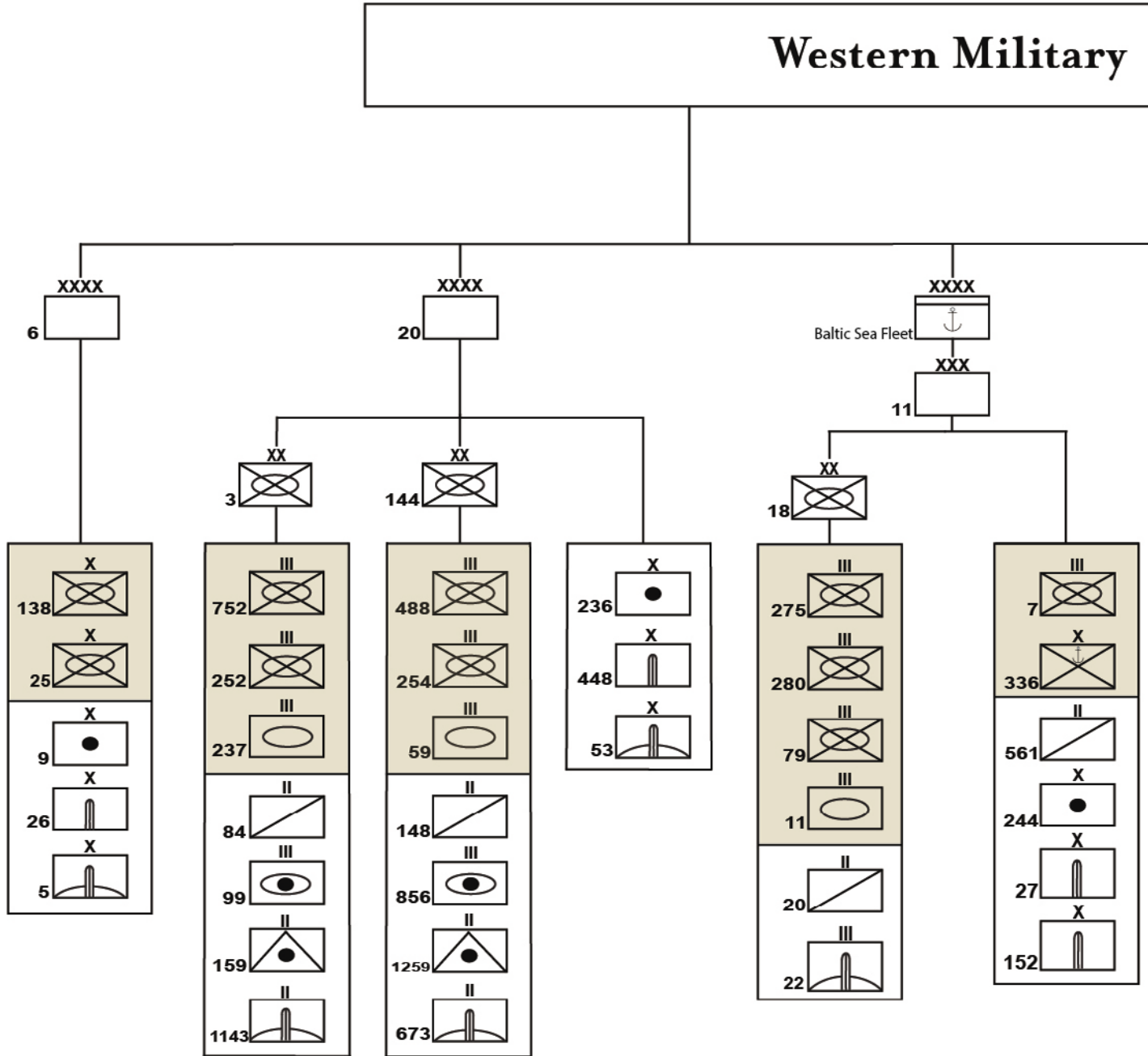

District

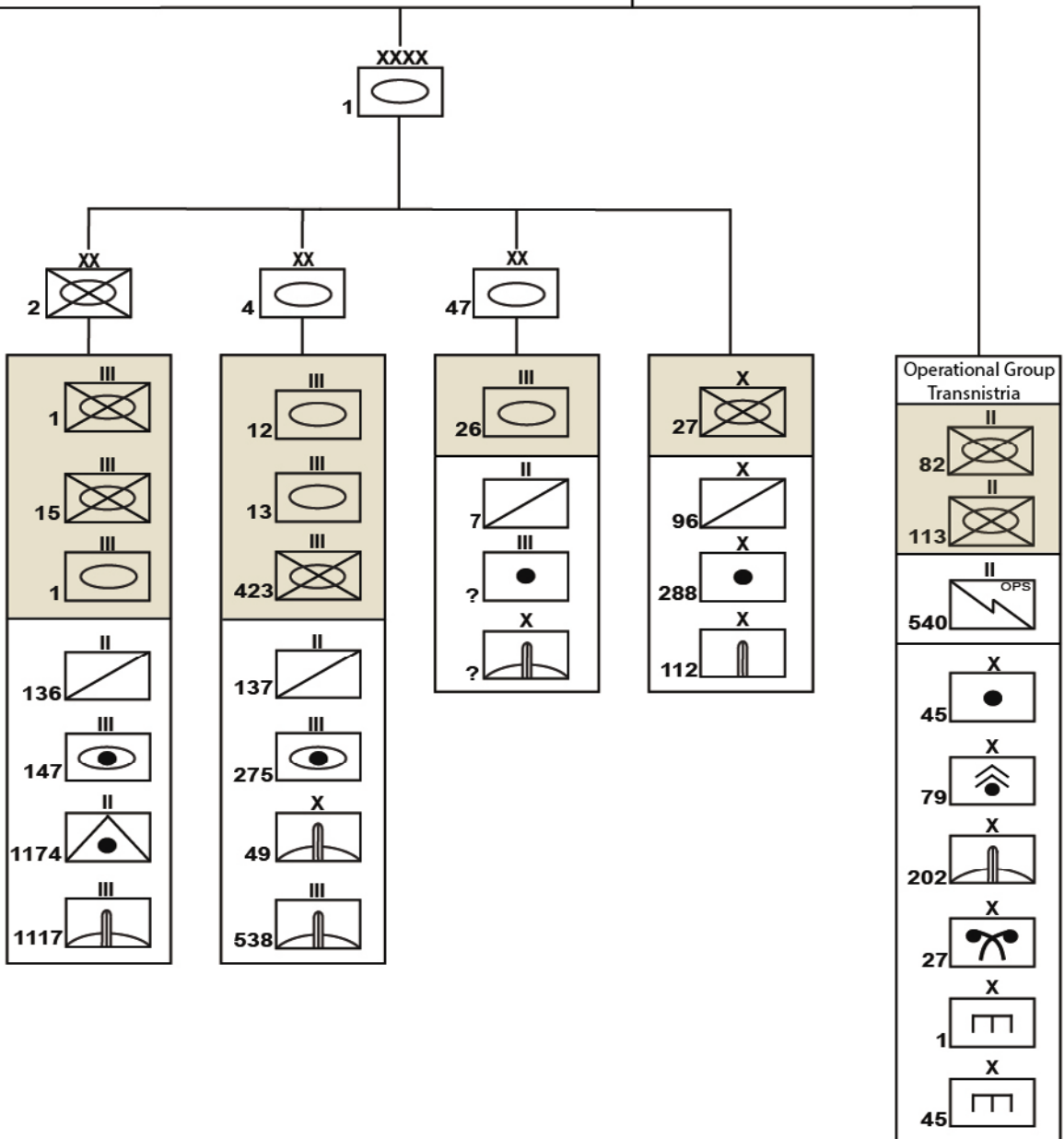

Russian Order of Battle

Southern Military

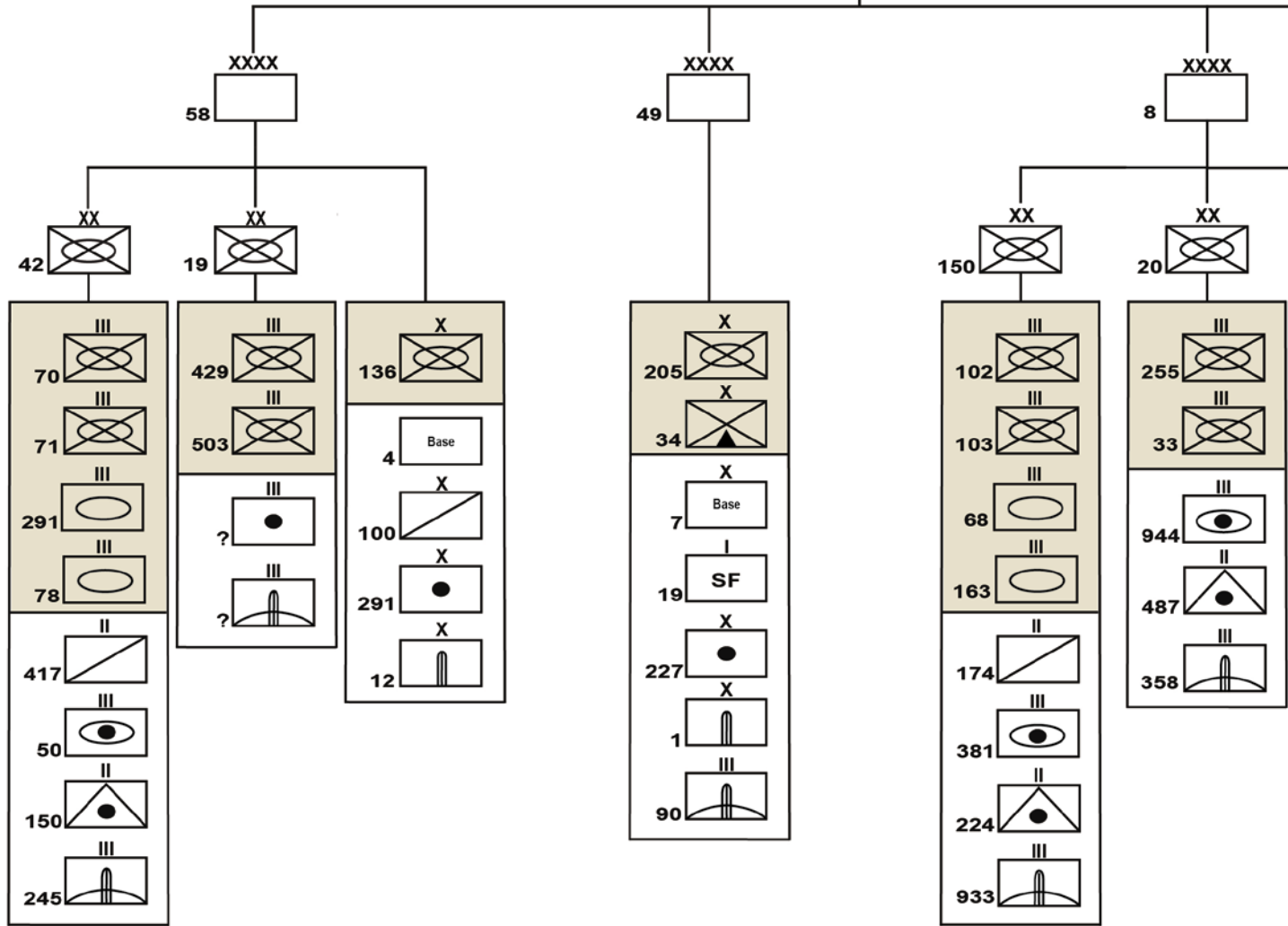

District

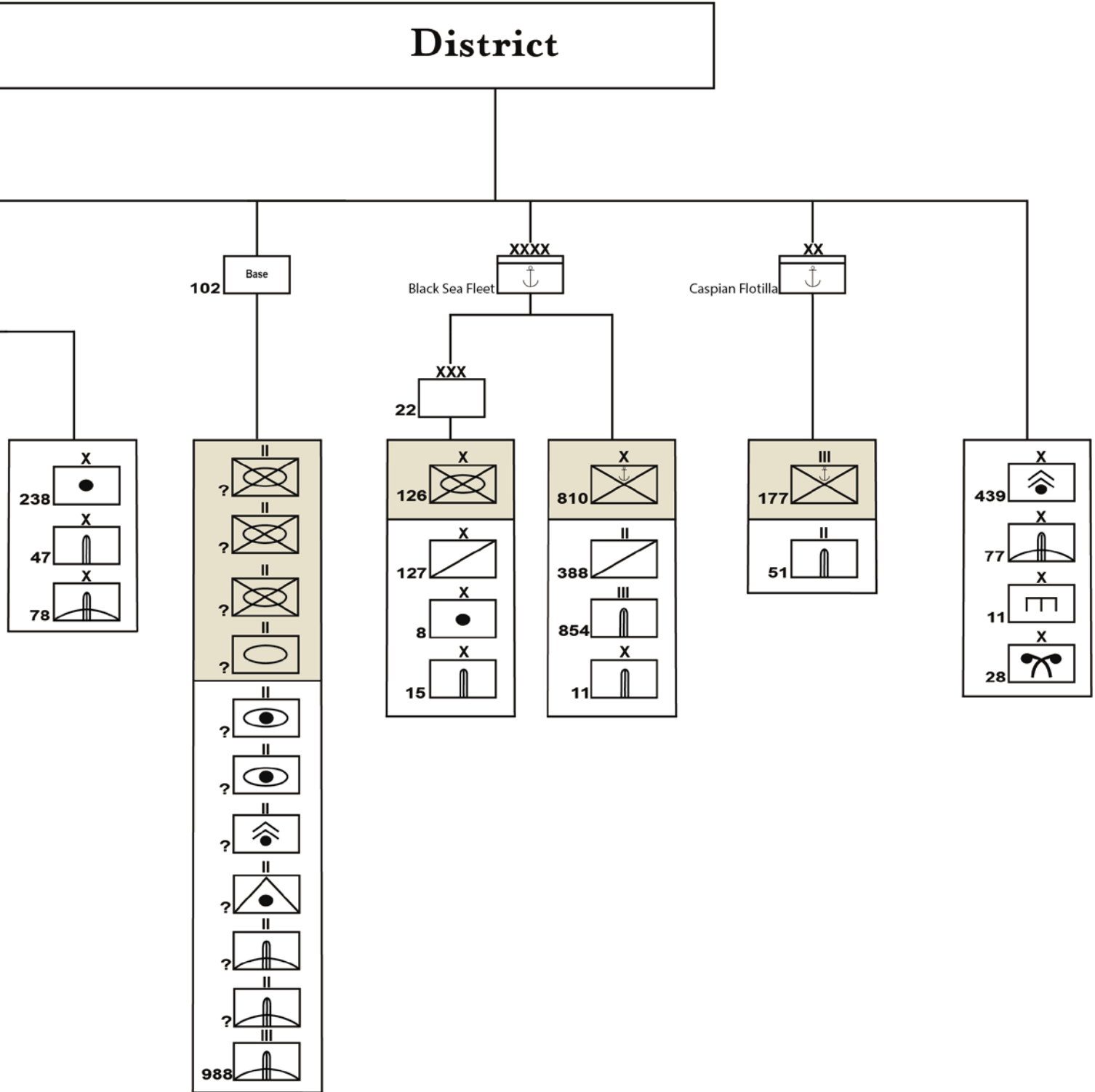

Central Military District

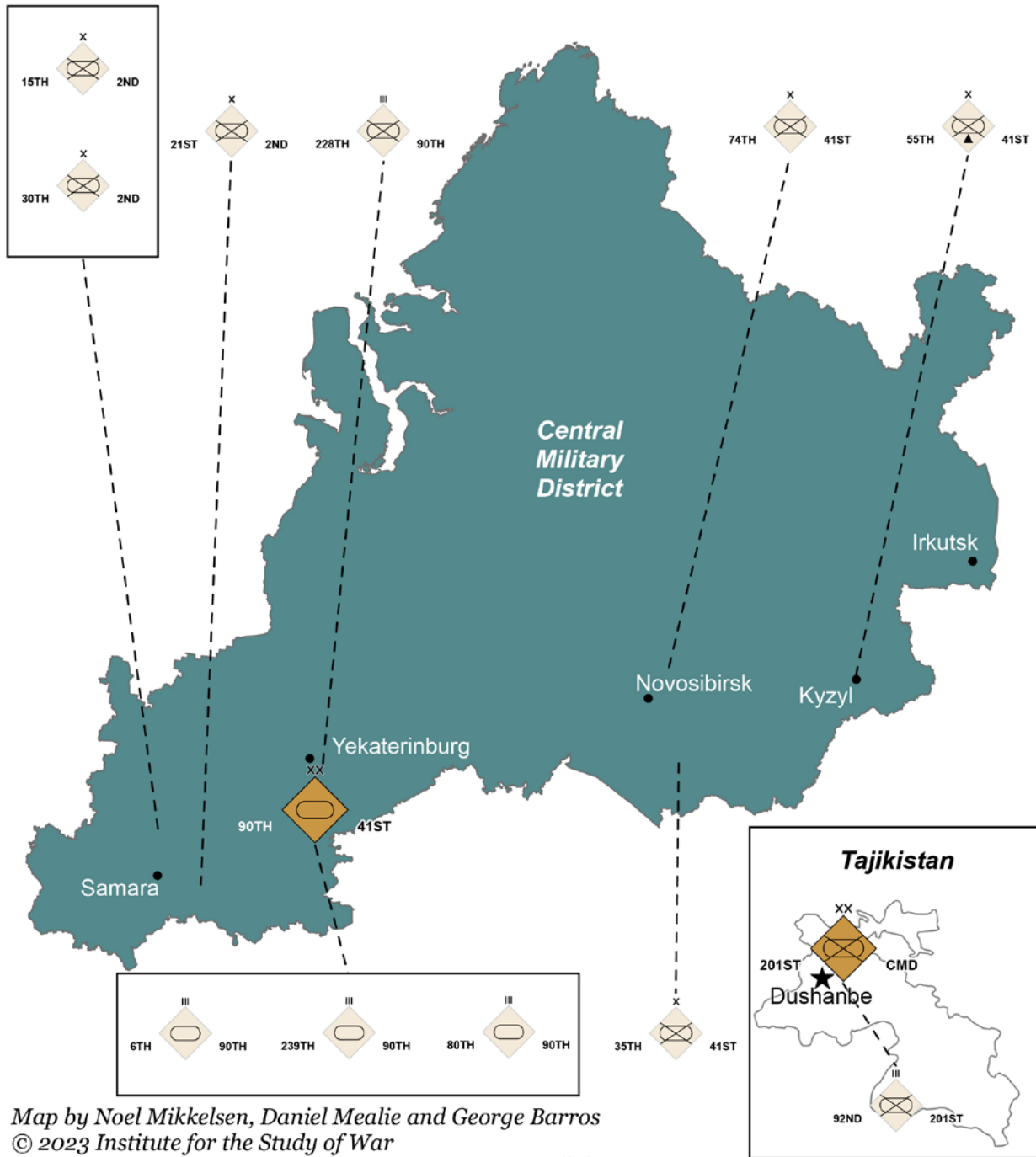

Russian Order of Battle

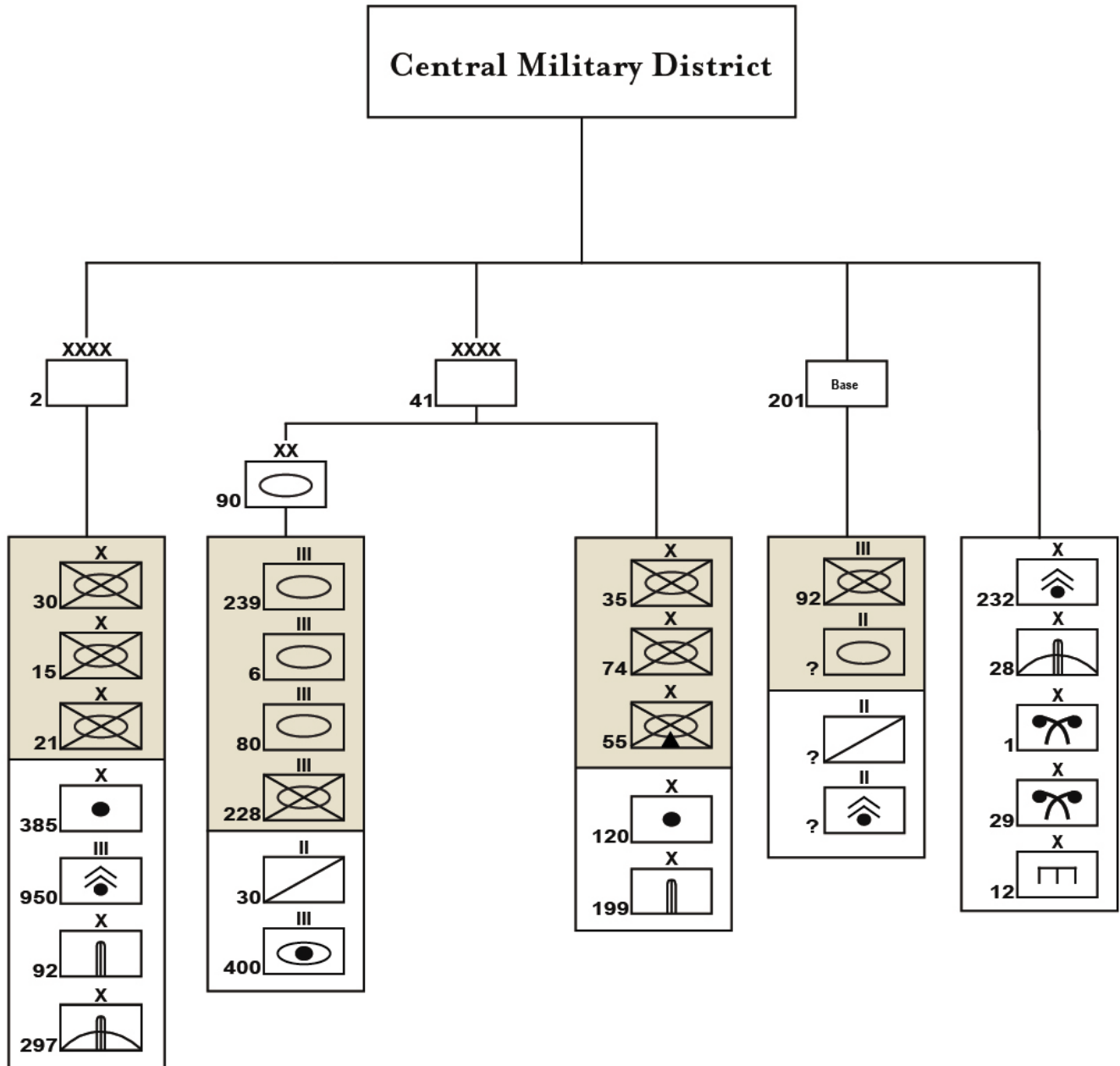

Eastern Military District

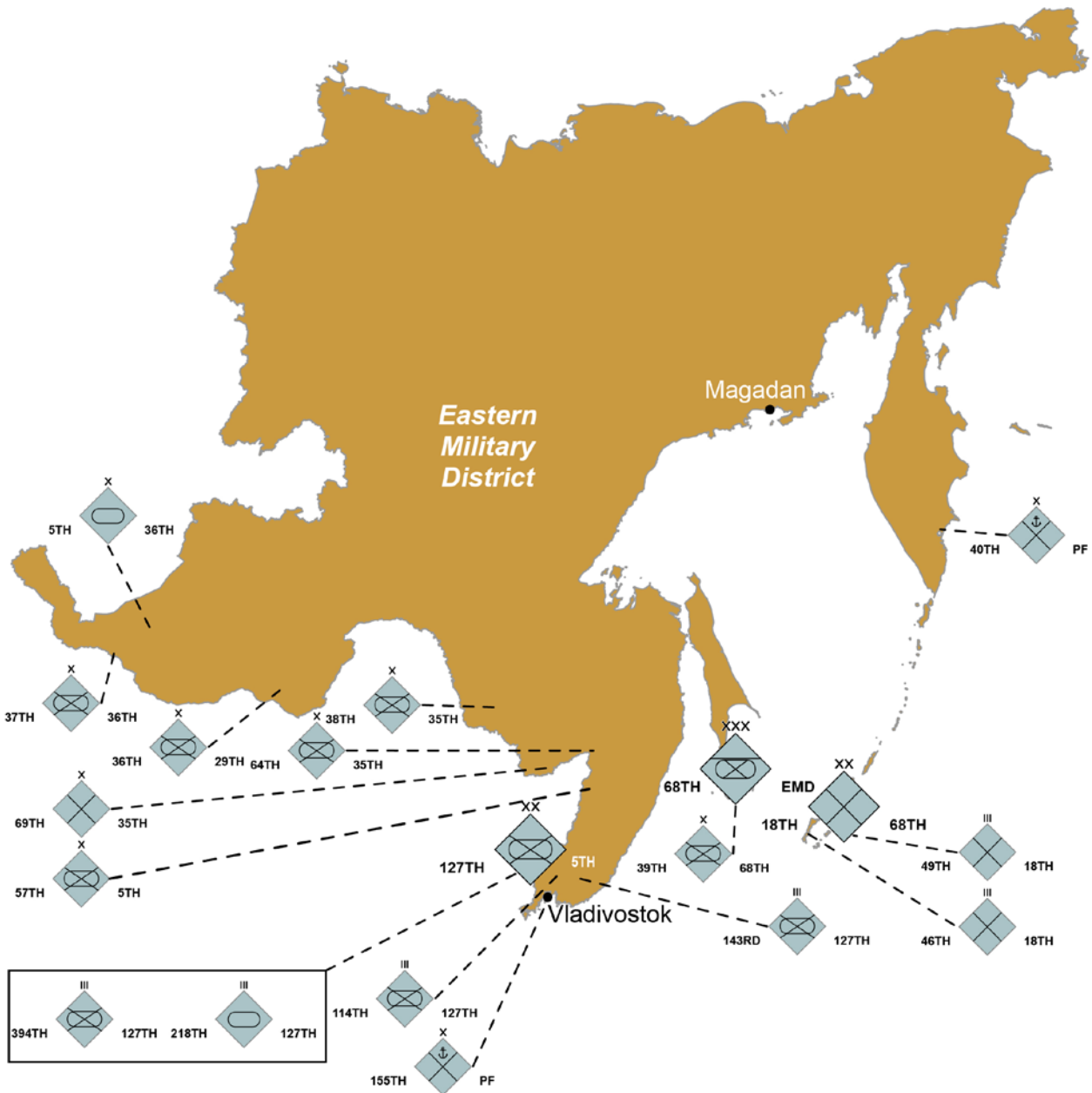

Map by Noel Mikkelsen, Thomas Bergeron, and George Barros
© 2023 Institute for the Study of War

Russian Order of Battle

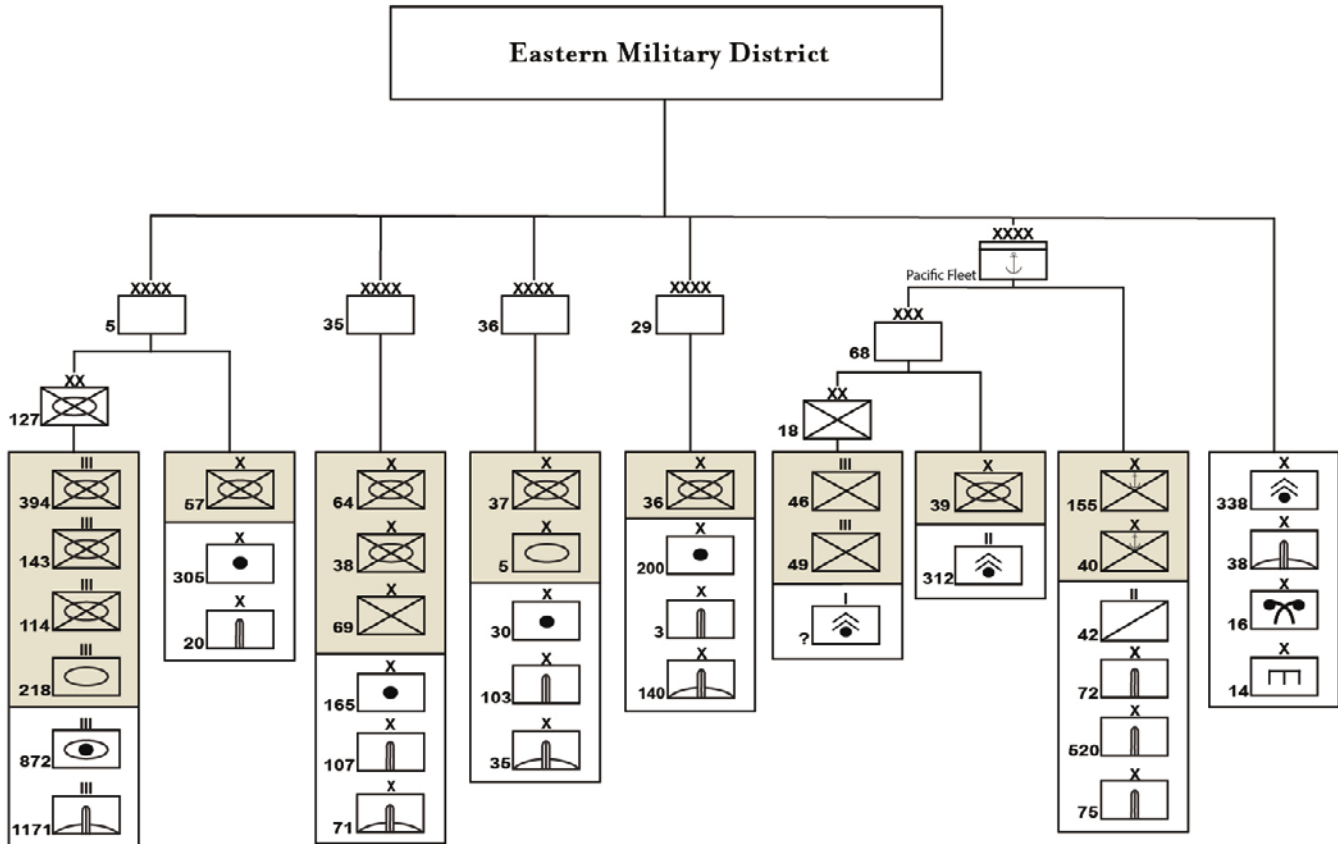

Northern Fleet and Arctic Joint Strategic Command



Map by Noel Mikkelsen, Daniel Mealie, and George Barros
© 2023 Institute for the Study of War

Russian Order of Battle

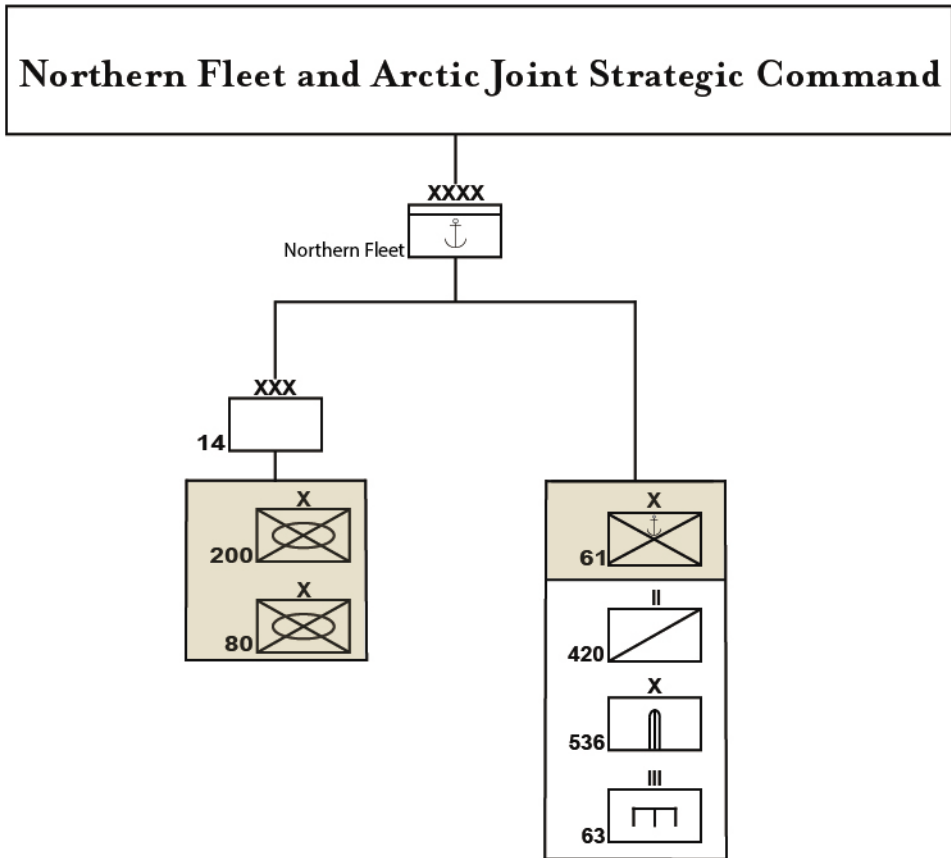

Russian Airborn Forces (VDV) Units

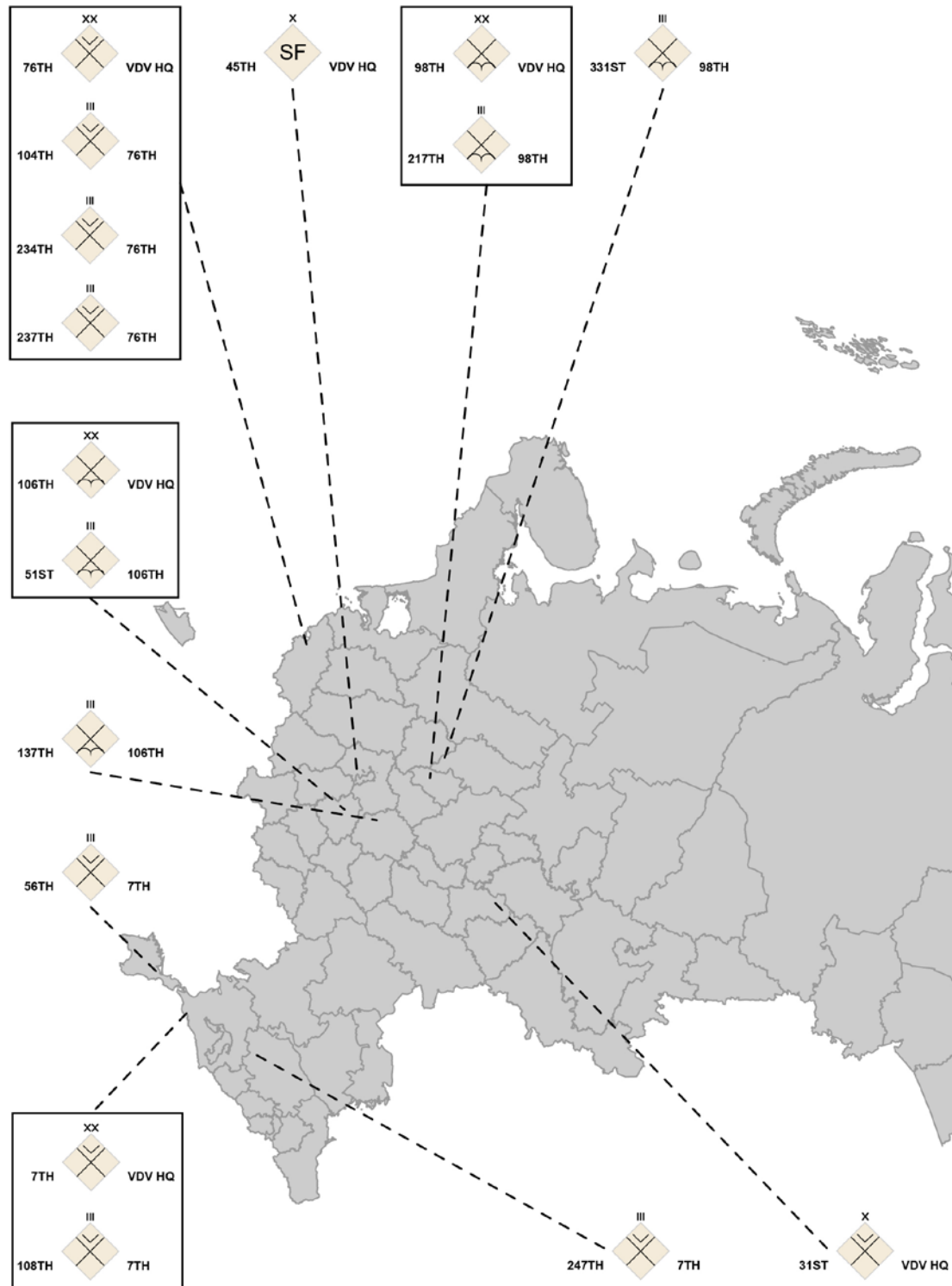

Map by Noel Mikkelsen and George Barros
© 2023 Institute for the Study of War



Russian Spetsnaz Units Subordinate to the General Staff's Main Intelligence Directorate (GRU)



Map by Noel Mikkelsen and George Barros
© 2023 Institute for the Study of War



Russian Order of Battle

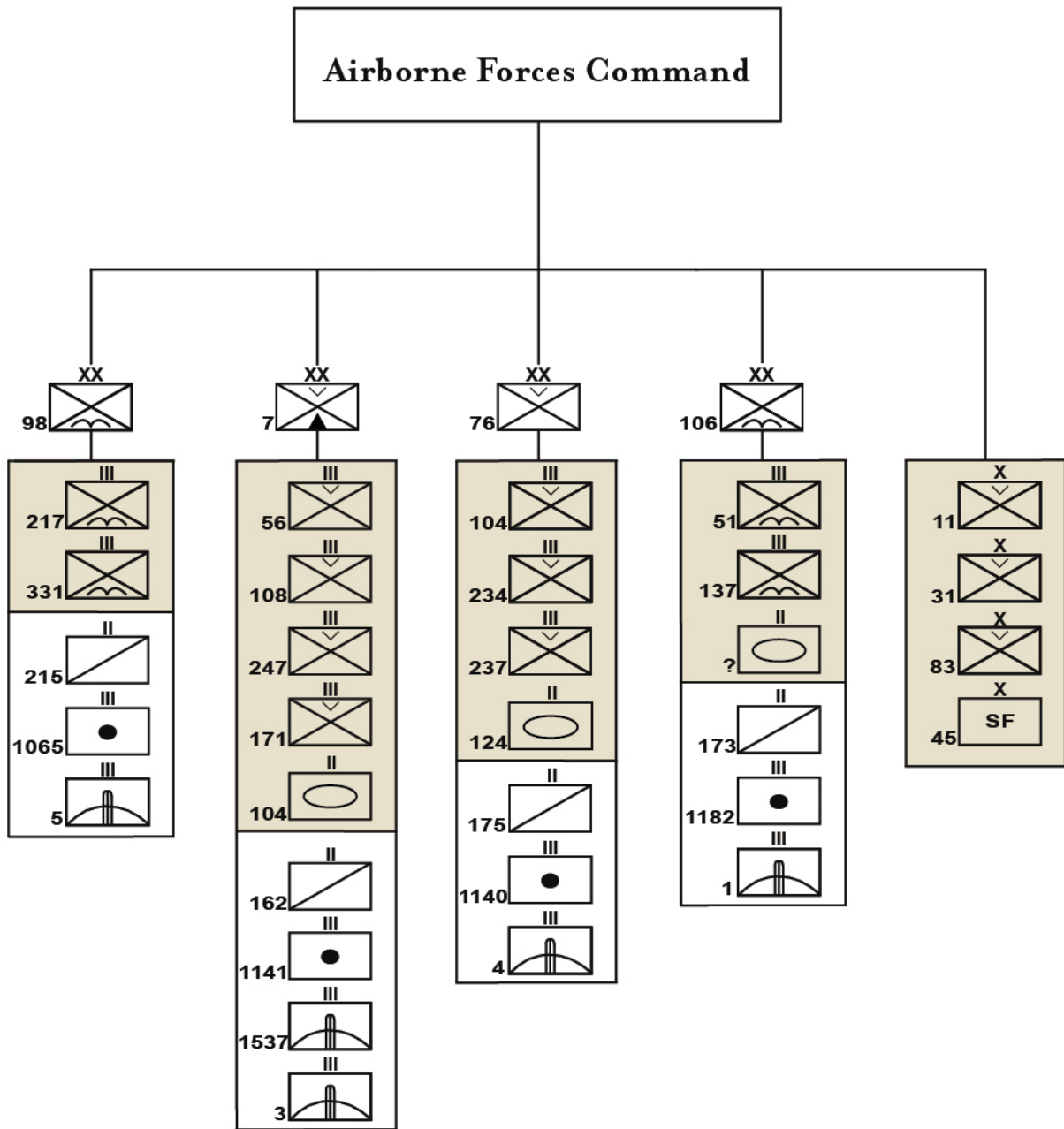





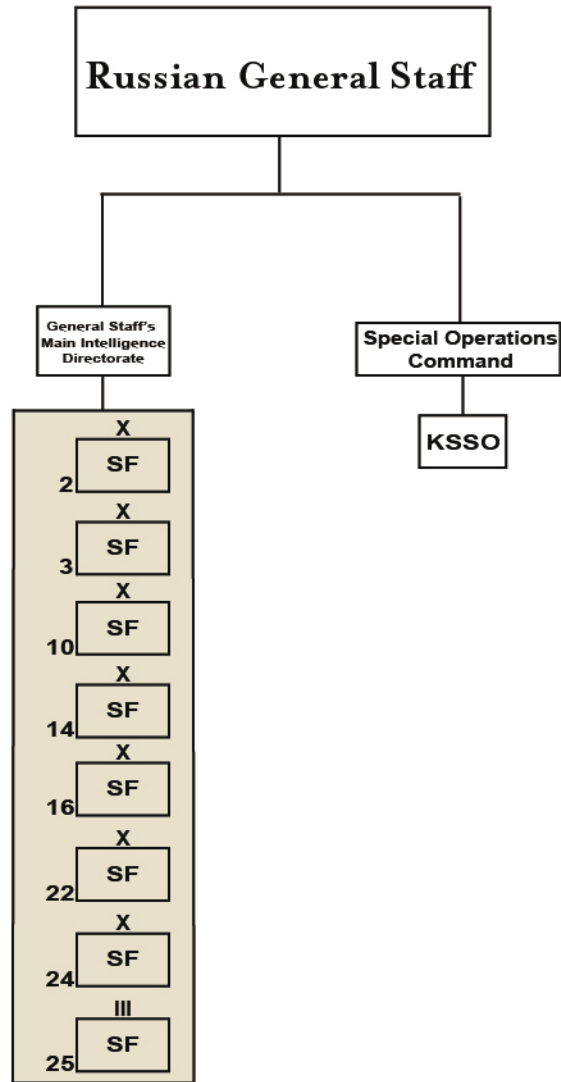















Russian Order of Battle

GRU Spetsnaz and Special Operations Command

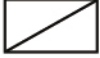

Russian Order of Battle

Key

	Indicates Combat Unit		
	Infantry		Missile
	Motor Rifle		Antiaircraft-Missile
	Mountain Infantry		Tank
	Mountain Motor Rifle		Military Base
	Naval Infantry		Artillery
	Airborne Infantry		Anti-Tank Artillery
	Air Assault Infantry		Self-Propelled Artillery
	Special Forces (Spetsnaz)		Reactive Artillery
	Reconnaissance		CBRN
	Engineer		Command and Control

Appendix A: Glossary of Russian Unit Types

Primary unit types

- **Motorized rifle:** Infantry mounted on tracked or wheeled armored personnel carriers, and the main combat power of the Russian ground forces. The entire Russian ground force is “mechanized,” in the Western parlance. Motorized rifle brigades and regiments have a paper strength of three motorized rifle battalions and one tank battalion.
- **Tank:** The main strike force of the Russian ground forces. Tank brigades and regiments have a paper strength of three tank battalions and one motorized rifle battalion.
- **Naval Infantry:** Russia’s marines, though in no way comparable to the US Marine Corps in size or joint capabilities. The Naval Infantry are fully mechanized and equipped similarly to motor rifle and VDV forces.
- **VDV:** Russia’s Airborne forces, and the elite of the regular Russian military. Contrary to common misconceptions, the VDV are considered the elite of the Russian military, not the GRU Spetsnaz units. VDV units are fully mechanized with airmobile specialty vehicles more lightly armored (but frequently as heavily armed) as motor rifle units. Airborne units are dropped via parachute, and air assault units operate via rotary wing aircraft.

Artillery

- **Regular:** Some Russian motorized rifle units continue to operate towed howitzer artillery.
- **Self-propelled:** The Russian army increasingly operates armored and mechanized artillery, and most CAA-level artillery batteries are self-propelled.
- **Rocket artillery:** Multiple Launch Rocket Systems (MLRS), most commonly the “Grad” system.
- **Anti-tank artillery:** Units equipped with a mix of self-propelled antitank artillery and ATGM-equipped vehicles.

Support units

- **Reconnaissance:** Dedicated ISR (Intelligence Surveillance, and Reconnaissance) units.
- **Missile brigade:** Short-range ballistic missile assets equipped primarily with the Iskander system. These units fill a tactical-operational precision fires niche often filled by air power in NATO militaries.
- **Anti-aircraft missile brigade:** Short and medium-range anti-air missile systems such as the “Strela” and “Tor.” Long range operational/strategic air defense assets such as the S-300 and S-400 are part of the Aerospace Defense Forces, not the Russian Army – and are not covered in this ORBAT.
- **Coastal missile:** “Bal” and “Bastion” anti-ship missile systems intended to defend Russian coastal waters.
- **Nuclear, Biological, and Chemical (NBC) Protection Troops:** NBC units operate thermobaric artillery systems, and are therefore included in this ORBAT as a combat support unit at the Military District level.
- **Spetsnaz:** Short for “spetsialnogo naznacheniya,” or “special purpose” units. Spetsnaz is often used as a general term for special operations forces operated by Russian security organizations such as Rosgvardia and the Ministry of Internal Affairs. This report uses this term to refer only to the military forces of the GRU (Main Intelligence Directorate, now technically simply the Main Directorate or “GU” but still commonly referred to as the GRU), the General Staff’s military intelligence organization. Spetsnaz units are directly subordinate to the General Staff through the GRU and are intended to serve as reconnaissance and sabotage units, but in practice have been pressed into service in Ukraine as light infantry in heavy fighting.
- **Special Operations Command:** Russia’s Special Operations Command (KSSO) was created in

March 2013 and is explicitly modeled on Western special forces. The KSSO reports directly to the General Staff – and does not run through the GRU, unlike Spetsnaz brigades. The KSSO is formed around the core of the 346th Special Purpose Brigade, which retains this unit designation in some reporting but is no longer a typical GRU Spetsnaz unit.

Unusual maneuver units

- **Machine gun artillery:** The EMD's 18th Machine Gun Artillery Division is a defensive unit assigned to defend the Kuril Islands from Japan, though it reportedly deployed to Ukraine in 2022. Functionally an understrength but artillery-heavy motorized rifle division.
- **Covering brigade:** The 69th Separate Covering Brigade is similar to the Machine Gun Artillery Division, an understrength and artillery-heavy motorized rifle brigade intended to provide initial defense of Russia's border with China.

- **Coastal defense:** The maneuver units of the Army Corps subordinated to Russia's Fleet Headquarters. Equipped, trained, and deployed as motorized rifle units.

Unit titles

- **Guards:** An honorary title assigned to units assessed to have shown heroism and elite qualities. Several Russian units have newly received the "Guards" title during the 2022 invasion of Ukraine, and as of late 2023 the title has little correlation with unit quality.
- **Mountain:** Several Army and VDV units, predominantly based in or near the Caucasus, are trained for combat in mountainous environments.
- **Arctic:** The Northern Fleet's 200th and 80th Brigades (only the 80th is formally designated "Arctic") are smaller than regular motorized rifle brigades and are trained and equipped for combat in the Arctic Circle.

Appendix B: Bibliography and Further Reading

Further reading on the Russian Armed Forces

- Mark Galeotti, *Putin's Wars: From Chechnya to Ukraine* (Oxford: Osprey, 2022) – An excellent general introduction to the Russian military's evolution from 1991 to February 2022 and general capabilities.
- Lester W. Grau and Charles K. Bartles, "The Russian Way of War: Force Structures, Tactics, and Modernization of the Russian Ground Forces," Foreign Military Studies Office, August 22, 2017, <https://www.armyupress.army.mil/portals/7/hot%20spots/documents/russia/2017-07-the-russian-way-of-war-grau-bartles.pdf> – This book by Grau and Bartles is the most detailed open-source guide available to Russian tactical and operational doctrine and force composition, including equipment details. This work is slightly out of date due to Russian force restructuring since 2016 and the return of divisions, but remains an essential source.
- Aleksei Ramm, "The Russian Army: Organization and Modernization," Center for Naval Analyses, October 1, 2019, <https://www.cna.org/reports/2019/10/IOP-2019-U-021801-Final.pdf> – This report is the best readable reference on Combined Arms Army (CAA) composition and the division vs brigade structure.
- Konrad Muzyka, "Russian Forces in the Western Military District," Center for Naval Analyses, June 1, 2021, <https://www.cna.org/reports/2021/06/Russian-Forces-in-the-Western-Military-District.pdf>; Konrad Muzyka, "Russian Forces in the Southern Military District," Center for Naval Analyses, August 24, 2021, <https://www.cna.org/reports/2022/01/Russian-Forces-in-the-Southern-Military-District.pdf> –

These two reports are excellent deep dives on the structure and pre-February 2022 capabilities of Russian forces in the Western and Southern Military Districts.

- Michael Kofman, Anya Fink, Dmitry Gorenburg, Mary Chesnut, Jeffrey Edmonds, and Julian Waller, “Russian Military Strategy: Core Tenets and Operational Concepts,” Center for Naval Analyses, August 6, 2021, https://www.cna.org/archive/CNA_Files/pdf/russian-military-strategy-core-tenets-and-operational-concepts.pdf – This report is a higher-level look at theoretical Russian military strategy. It situates the Russian units covered in this ORBAT in doctrinal Russian thinking and excellently explains how the districts are theoretically intended to function in wartime. This report also includes a valuable glossary of the definitions of Russian military terms.
- Timothy L. Thomas, “Russian Military Thought: Concepts and Elements,” MITRE Corporation, August 8, 2019, <https://www.mitre.org/sites/default/files/2021-11/prs-19-1004-russian-military-thought-concepts-elements.pdf> – A detailed and holistic study of Russian military thinking and conceptualization of modern and future war.
- Mykhaylo Zabrodskyi, Jack Watling, Oleksandr V. Danylyuk, and Nick Reynolds, “Preliminary Lessons in Conventional Warfighting from Russia’s Invasion of Ukraine: February–July 2022,” Royal United Services Institute, November 30, 2022, <https://static.rusi.org/359-SR-Ukraine-Preliminary-Lessons-Feb-July-2022-web-final.pdf> – A fantastic analysis of Russian and Ukrainian performance in the initial months of the 2022 invasion of Ukraine, including discussion of Russia’s deviations from established doctrine in initial lessons learned applicable to conventional warfighting writ large.
- Jack Watling and Nick Reynolds, “Meatgrinder: Russian Tactics in the Second Year of Its Invasion of Ukraine,” Royal United Services Institute, May 19, 2023, <https://static.rusi.org/403-SR-Russian-Tactics-web-final.pdf> – Another excellent RUSI report, covering Russian tactics and adaptations in early 2023.
- Scott Boston and Dara Massicot, “The Russian Way of Warfare: A Primer,” RAND Corporation, 2017, <https://www.rand.org/pubs/perspectives/PE231.html> – Similar to this report, this RAND work is an introduction to Russian military thinking for non-experts, but with a focus on theoretical Russian approaches to conventional war with NATO.

Further reading on the Battalion Tactical Group

- Lester W. Grau and Charles K. Bartles, “Getting to Know the Russian Battalion Tactical Group,” Royal United Services Institute, April 14, 2022, <https://rusi.org/explore-our-research/publications/commentary/getting-know-russian-battalion-tactical-group> – An excellent primer on the Russian BTG, written in the early months of the 2022 invasion of Ukraine.
- Nicolas J. Fiore, “Defeating the Russian Battalion Tactical Group,” *ARMOR Mounted Maneuver Journal* Vol. 128, No. 2 (Spring 2017): pp. 9–17, <https://www.benning.army.mil/armor/earmor/content/issues/2017/spring/2Fiore17.pdf> – An article assessing tactics for US Brigade Combat Teams to defeat Russian BTGs.
- Michael Kofman and Rob Lee, “Not Built for Purpose: The Russian Military’s Ill-Fated Force-Design,” *War on the Rocks*, June 2, 2022, <https://warontherocks.com/2022/06/not-built-for-purpose-the-russian-militarys-ill-fated-force-design/> – The best general report available on the Russian use of BTGs in the specific context of Ukraine in 2022.
- Amos C. Fox, “Reflections on Russia’s 2022 Invasion of Ukraine: Combined Arms Warfare, The Battalion Tactical Group and Wars in a Fishbowl,” Association of the United States Army, September 29, 2022, <https://www.ausa.org/publications/reflections-russias-2022-invasion-ukraine-combined-arms-warfare-battalion-tactical> – An interesting report on Russian failures over projecting the utility of BTGs in Ukraine in 2014–2015 with disastrous results in 2022.

Endnotes

- 1 <https://tass dot ru/armiya-i-opk/2150702>; <https://iz dot ru/news/612939>; <https://tass dot ru/obschestvo/3593714>
- 2 https://bizbi dot ru/handbook/vooruzhennye_sily/voen-nye_chasti_narofominska/77360/; <https://army-today dot ru/wch/23626>; <https://du-lya dot ru/articles/tamanskaya-diviziya-adres-podmoskove.html>
- 3 <https://voinskaya-chast dot ru/vooruzhennye-cily/cuxoputnye-vojska/I-motostrelkovyj-polk-tamanskoj-divizii-voinskaya-chast-31135.html>; <https://mamasoldata.mybb dot ru/view-topic.php?id=863>
- 4 <https://vk dot com/club7706879>; <https://admiral55 dot ru/kontrakt/vch-31134.html>; <https://prizivniku dot com/voenchast/voinskaya-chast-31134>
- 5 <https://www.youtube.com/watch?v=PPsGPfbEuVg>; <https://arograf dot ru/kontraktnaya/vch-61896.html>
- 6 <http://www.bolshoyvopros dot ru/questions/1568145-narofominskij-rajon-pkalininec-51387-voinskaja-chast-cto-zavojnska.html>; <https://mf-bagration dot ru/kontrakt/alabino-moskovskaya-oblast-voinskaya.html>; <http://shaked-il dot blog-spot.com/2017/07/1.html>
- 7 <https://www.pnp dot ru/social/shefy-iz-simferopolya-positili-podmoskovnyy-polok.html>; <http://simadm dot ru/press/government/19869/>
- 8 https://vk dot com/wall-106415781_3007; <https://toparmiya dot ru/pomoshh-prizyvnikam/voennaya-služba/tamanskaya-diviziya>
- 9 <https://ok dot ru/voyskovoep/album/59289111429171>; https://vk dot com/wall-106415781_3007
- 10 <https://armyru dot com/suhoputnye-vojska/tankovye-vojska/4-ia-gvardeiskaia-kantemirovskaia-tankovaia-diviziia-v-ch-19612/>; <https://army-today dot ru/wch/19612>; <https://prizivniku dot com/voenchast/vch-19612-narofominske>; <https://voinskajachast dot net/suhoputnie-vojska/tankovie/vch19612>
- 11 https://bizbi dot ru/news/sobytiya/12_tankovyy_polok_kantemirovskoy_divizii_otmetil_den_rozhdeniya/; <https://voinskajachast dot net/suhoputnie-vojska/tankovie/vch31985>; <https://armyru dot com/suhoputnye-vojska/tankovye-vojska/12-i-tankovyi-polok-kantemirovskoi-tankovoi-divizii-v-ch-31985/>
- 12 <https://voinskajachast dot ru/suhoputnye-vojska/tankovye-vojska/voinskaya-chast-32010-13-yy-tankovyy-polok/>; <https://poiski dot pro/group/vch32010>
- 13 <https://army-today dot ru/wch/91701>; <https://t.me/svobodnieslova/904>; <https://prizivniku dot com/podrazdeleniya/yampolskiy-polok-kantemirovskoy-divizii>
- 14 <https://m.ok dot ru/group137otdelny>; <https://pomnirod dot ru/materialy-k-statyam/rossiya-poslerevolucionnaya/voennye/voinskije-podrazdeleniya1/tankisty/tankovye-divizii/4-ya-tankovaya-diviziya/3-j-tankovoj-divizii/137-j-otdelnyj-razvedyatelnyj-dembickij-krasnoznamyennyj-ordena-aleksandra-nevskogo-batalon-v-ch-54919-g.-narofominsk.html>; <https://prizivniku dot com/voenchast/vch-19612-narofominske>
- 15 https://vk dot com/wall-66190688_781966; <https://xn--biaadsxd dot xn--p1ai/strelkovoe-oruzhie/sostav-vzvoda.html>
- 16 <https://rabota.smolensk dot ru/employer/detail/?companyId=497f9b04-1581-11e9-826e-000c2973da2c>; <https://smolgazeta dot ru/daylynews/105949-edinorossy-pozdravili-49-zenitnuyu-raketnuyu.html>
- 17 <https://army-today dot ru/wch/51383>; <https://www.wikiwand dot com/ru/538-%D0%B9-%D0%B3%D0%B2%D0%B0%D1%80%D0%B4%D0%B5%D0%B9%D1%81%D0%BA%D0%B8%D0%B9-%D0%B7%D0%B5%D0%BD%D0%B8%D1%82%D0%BD%D1%8B%D0%B9-%D1%80%D0%B0%D0%B5%D1%82%D0%BD%D1%8B%D0%B9-%D0%BF%D0%BE%D0%BB%D0%BA>
- 18 https://t.me/bmpd_cast/10512; <https://bmpd dot livejournal.com/4487210.html>
- 19 <https://moyaokruza dot ru/gazetaznamia/Articles.aspx?articleId=503475>; https://vk dot com/wall14720601_2802
- 20 <https://vechnayapamyat dot net/tag/7-%D0%B9-%D0%BE%D1%82%D0%B4%D0%B5%D0%BB%D1%8C%D0%BD%D1%8B%D0%B9-%D1%80%D0%B0%D0%B7%D0%B2%D0%B5%D0%B4%D1%8B%D0%B2%D0%B0%D1%82%D0%B5%D0%BB%D1%8C%D0%BD%D1%8B%D0%B9-%D0%B1%D0%B0%D1%82%D0%B0%D0%BB%D1%8C/>
- 21 <https://imosrentgen dot ru/vch-61899/>; <https://vk dot com/osmbr?w=club32748567>
- 22 <https://voinskajachast dot ru/suhoputnye-vojska/specialnye-vojska/vch-52634-nizhny-novgorod-96-aya-obrr/>; <https://29 dot ru/text/incidents/2020/01/22/66457096/>
- 23 <https://armyru dot com/suhoputnye-vojska/raketnye-vojska-i-artilleriya/288-ia-artilleriiskaia-brigada-v-ch-30683/>; https://vk dot com/artbrigada_288?w=club2100227
- 24 <https://vk dot com/@sivestiya-shuiskaya-112-ya-gvardeiskaya-raketnaya-brigada-otprazdnoval>; https://newsivano dot ru/fn_932649.html
- 25 <https://geraldika dot ru/s/14025>; <https://voinskaya-chast dot ru/voinskije-chasti-v-gorodax/voinskije-chasti-goroda-sankt-peterburga-i-leningradskoj-oblasti.html>
- 26 <https://voinskajachast dot ru/suhoputnye-vojska/motostrelkovye-vojska/vch02511/>; <https://rossaprimavera dot ru/news/e3945965>
- 27 https://vk dot com/wall-49813043_181738; <https://47news dot ru/articles/200309/>
- 28 <https://vk dot com/club147237670>; <https://wikimapia dot org/19633622/ru/9-%D1%8F-%D0%B3%D0%B2%D0%B0%D1%80%D0%B4%D0%B5%D0%B9-%D1%81%D0%BA%D0%B0%D1%8F-%D0%B0%D1%80%D1%82%D0%B8%D0%BB%D0%BB%D0%B5%D1%80%D0%B8%D0%B9%D1%81%D0%BA%D0%B0%D1%8F-%D0%B1%D1%80%D0%B8%D0%B3%D0%B0%D0%B4%D0%B0-%D0%B2-%D1%87-02561>; <https://armyru dot com/suhoputnye-vojska/raketnye-vojska-i-artilleriya/9-ia-gvardeiskaia-artilleriiskaia-brigada-v-ch-02561/>
- 29 <https://vk dot com/club2577807>; <https://armyru dot com/voinskije-chasti-v-gorodax/voinskije-chasti-sankt-peterburga-i-leningradskoj-oblasti/>

- 30 <https://bmpd dot livejournal.com/3147890.html>;
<https://37kp dot ru/%D0%B4%D0%B5%D0%BD%D1%8C-%D1%87%D0%B0%D1%81%D1%82%D0%B8-5-%D1%8F-%D0%B7%D1%80%D0%B1%D1%80-05-12/>
- 31 <https://xn---8sbemfmcdd0ala1ajk dot xn--p1ai/wiki/2/7235/>;
https://m.facto dot ru/glavnaya_lenta_novostej/2017/02/komandovat_20_y_armiey_budet_uchastnik_boevykh_deystviy_general_mayor_aleksandr_peryazev/?sphrase_id=7484780
- 32 <https://vk dot com/army54046>; <https://prizivniku dot com/voenchast/voinskaya-chast-54046>
- 33 <https://army-today dot ru/wch/34670>; <https://rg dot ru/2018/11/19/reg-cfo/v-zapadnom-voennom-okruga-poia-vilas-pervaia-kazachia-rot.html>; <https://prizivniku dot com/voenchast/voennaya-chast-34670-valuykah>
- 34 <https://prizivniku dot com/voenchast/voennaya-chast-91711-gorode-boguchar-voronezhskoy-oblasti>;
<https://iz dot ru/news/657603>
- 35 <https://vk dot com/vh91726>; https://www.komandirovka dot ru/sights/valuiki/237-y-tankovyy-polk/#anchor_contacts
- 36 <https://otvet.mail dot ru/question/78447087>; <https://informnapalm dot org/en/valuyki-boguchar-common-markings-military-equipment-operated-russian-army-lpr/>; <https://web.archive.org/web/20170419224721/http://www.milkavkaz.net/2015/12/zapadnyj-voennyj-okrug.html>
- 37 https://vk dot com/artpolk_99; https://censor dot net/ru/photo_news/442815/rf_zhgod_udvoila_kolichestvo_voorujeniya_na_granitse_s_ukrainoyi_na_bazah_v_valuykah_i_boguchare_tehniku
- 38 <https://mamasoldata.mybb dot ru/viewtopic.php?id=5359>
- 39 <https://ok dot ru/voyskovoep/album/57458568265779>;
<https://ok dot ru/voyskovoep/album/56878469873715>; <http://eurasian-defence dot ru/?q=node/44327>; <https://informnapalm dot org/en/valuyki-boguchar-common-markings-military-equipment-operated-russian-army-lpr/>
- 40 <https://vk dot com/msd144>; <https://mamasoldata.mybb dot ru/viewtopic.php?id=6025&p=61>; <http://smolvet-eran dot ru/2022/07/23/%D0%B2-%D0%B5%D0%B-%D1%8C%D0%BD%D0%B5-%D0%B-F%D1%80%D0%BE%D1%88%D0%BB%D0%BE-%D0%B-F%D1%80%D0%B0%D0%B7%D0%B4%D0%B-D%D0%BE%D0%B2%D0%B0%D-%D0%BD%D0%B8%D0%B5-100-%D0%BB%D0%B5%D1%82%D0%B8%D1%8F-%D1%81%D0%BE/>; <https://www.smol.kp dot ru/online/news/5282509/>
- 41 <https://rabota-bryanskobl dot ru/employer/detail/?companyId=683cfd58-8838-43c4-bda2-662fc1784f29>; <https://www.klinci dot ru/news/64/9314/>; <https://smartik dot ru/klincy/post/173915604>
- 42 <https://vk dot com/mspkincivsh12721>; <https://www.rbc dot ru/politics/29/07/2022/62e3d4479a7947406989981d>; <https://army-today dot ru/wch/12721>
- 43 <https://voenpro dot ru/celedar/15-fevralya-den-chasti-59-gvardejskogo-tankovogo-polka>; <https://svgb-dvr dot ru/istoriya-odin-iz-nashikh-navechno-v-pamyati>; <https://soldiersmothers dot ru/actualno/soobshheniya-iz-voennyh-chastej-soldaty-myorznut-i-boleyut>
- 44 https://vk dot com/wall-91497952_2247; <https://smoldaily dot ru/voennyie-razvedchiki-na-svooy-99-letie-podarili-smolyanam-grandioznoe-shou>
- 45 https://vk dot com/wall-123538639_1303422; <https://pochep dot bezformata.com/listnews/dela-i-zaboti-vojskovoj-chasti/54685458/>; <https://www.bryansk.kp dot ru/online/news/3165406/>; <https://bryansk dot news/2020/03/23/army-4/>; <https://bmpd dot livejournal.com/3965326.html>;
- 46 <https://voenpro dot ru/infolenta/voentorgi-v-smolenske>;
<https://xn---8sbnmfccddjnj8adf dot xn--p1ai/wiki/1/3927/>
- 47 <https://smolensk dot nashaspravka.ru/podskazhite-pozhaluysta-na-kakoy-ulitse-nahoditsya-voinskaya-chast-53821-673-otdelnyy-zenitno-raketnyy-divizion-5157835>; http://sgvs.sml dot sudrf.ru/modules.php?name=docum_sud&id=321
- 48 <https://kolomna-spravka dot ru/news/46805>;
<https://armiyapro dot ru/srochnaya-sluzhba/vojskovaya-chast-43556-uts-bp-rvia>
- 49 <https://sdelanounas dot ru/blogs/131211/>; <https://vk.com/club45840695>; <http://konsulan dot ru/voinskaja-chast-raketnaja-v-p-zhukova-35535-komandovanie-chasti-34341/>
- 50 <https://m.ok dot ru/group/50442392764549/topic/66753713589125>; <https://dddkursk dot ru/lenta/2023/02/21/095169/>; <https://topwar dot ru/131141-raketnaya-brigada-v-kurskoy-oblasti-perevooruzhaetsya-na-zrkbuk-m3.html>
- 51 https://www.audit-it dot ru/contragent/1093925038272_fku-voyskovaya-chast-51280-upravlenie-baltiyskogo-flota;
<https://mamasoldata.mybb dot ru/viewtopic.php?id=5034>;
https://soyuzveteranov dot ru/sites/default/files/regiony_foto/klngd/320%20%D0%BB%D0%B5%D1%82%20%D0%91%D0%B0%D0%BB%D1%82%D0%B8%D0%B9%D1%81%D0%BA%D0%BE%D0%BC%D1%83%20%D1%84%D0%BB%D0%BE%D1%82%D1%83%20%D0%BE%D1%82%D0%BC%D0%B5%D1%82%D0%B8%D0%BB%D0%B8%20%D0%B2%20%D0%9A%D0%B0%D0%BB%D0%B8%D0%BD%D0%B8%D0%BD%D0%B3%D1%80%D0%B0%D0%B4%D0%B5.pdf
- 52 https://vk dot com/wall-150703306_74299; <https://www.komersant dot ru/doc/3866301>; <https://gusev-online dot ru/news/obshestvo/19235-komandujuschij-bf-vruchil-shtand-art-komandiru-armejskogo-korpusa-v-guseve.html>
- 53 <https://topwar dot ru/182937-nazvany-sroki-formirovaniya-novoj-motostrelkovoj-divizii-v-kaliningradskoj-oblasti.html>; <https://archive dot md/tkImT>
- 54 https://web.archive.org/web/20211016150448/https://function.mil.ru/news_page/country/more.htm?id=12358720@egNews; <https://iz dot ru/1163060/aleksei-ramm-anna-cherepanova-na-i-diviziia-v-kaliningrade-zavershaiut-sozdanie-novogo-soedineniia>
- 55 https://web.archive.org/web/20211016150448/https://function.mil.ru/news_page/country/more.htm?id=12358720@egNews; <https://iz dot ru/1163060/aleksei-ramm-anna-cherepanova-na-i-diviziia-v-kaliningrade-zavershaiut-sozdanie-novogo-soedineniia>
- 56 <https://iz dot ru/1163060/aleksei-ramm-anna-cherepanova-na-i-diviziia-v-kaliningrade-zavershaiut-sozdanie-novogo-soedineniia>; <https://voinskaya-chast dot ru/vooruzhennye-cily/voenno-morskoj-flot/beregovye-vojska/gorod-gusev-voinskaya-chast-90151.html>
- 57 <https://gusev-online dot ru/news/obshestvo/15545-v-gorode-guseve-sformirovan-tankovyy-polk.html>; <http://ursa-tm dot ru/forum/index.php?/topic/300696-v-kaliningradskoy-oblasti-sformirovan-ii-y-otdelnyy-tankovyy-polk/>

- 58 https://vk.com/wall-52075449_4532; <https://iz dot ru/1134600/anton-lavrov-aleksei-ramm/v-tylu-srazhenii-kaliningrad-zashchitiat-sverkhdialnie-razvedchiki>
- 59 <https://sdelanounas dot ru/blogs/125197/>; <https://safari-in-afrika dot ru/armiya-drugoe/v-ch-06414.html>; <https://iz dot ru/750816/aleksei-ramm-aleksandr-kruglov-bogdan-stepovoi/moriaki-baltiitcy-vozmot-pod-okhranu-mundial>
- 60 <https://army-today dot ru/wch/06414>; <https://mamasoldata dot mybb.ru/viewtopic.php?id=1686&p=17>; <https://voinskaya-chast dot ru/vooruzhennye-cily-cuxoputnye-vojska/motostrelkovye-vojska/voinskaya-chast-06414-7-otdelnyj-gvardej-skij-motostrelkovyj-polok.html>; <https://www.militarynews dot ru/story.asp?rid=1&nid=418358&lang=RU>
- 61 <https://army-today dot ru/wch/06017>; <https://iz dot ru/1204780/roman-kretcul-anna-cherepanova/baltike-treshka-kaliningradskie-morpekhi-poluchat-bmp-3f>; <https://voinskajachast dot ru/voenno-morskoy-flot/beregovye-voyska/voinskaya-chast-06017-baltiysk-kaliningra/>
- 62 <https://8war dot ru/ipoteka/parusnoe-kaliningradskaya-oblast-specnaz.html>; https://vk dot com/wall-186335996_4728; <https://37kp dot ru/%D0%B4%D0%B5%D0%BD%D1%8C-%D1%87%D0%B0%D1%81%D1%82%D0%B8-561-%D0%B9-%D0%BC%D0%BE%D1%80%D1%81%D0%BA%D0%BE%D0%B9-%D1%80%D0%B0%D0%B7%D0%B2%D0%B5%D0%B4%D0%BF%D1%83%D0%BD%D0%BA%D1%82-%D0%B1%D1%84-29-12/>; https://vk dot com/wall-46943161_1382159
- 63 <https://iz dot ru/1496279/roman-kretcul-aleksei-ramm/artileriiskii-tolk-kaliningradskuii-oblast-usilili-rszo-i-gaubitcami>; <https://iz dot ru/1393859/roman-kretcul-aleksei-ramm/poverka-reakcii-baltiku-protestirovali-na-zashchitu-ot-giperzvukovogo-udara>; <https://iz dot ru/1204780/roman-kretcul-anna-cherepanova/baltike-treshka-kaliningradskie-morpekhi-poluchat-bmp-3f>; <https://mamasoldata dot mybb.ru/viewtopic.php?id=4384&p=4>
- 64 <https://vesti-kaliningrad dot ru/znamenitoe-soedinenie-iz-chernyaxovska-otmechaet-yubilej/>; <https://www.angrapa dot ru/news/novosti-goroda-i-rajona/6313-u-152-gvardejskoj-yubilej.html>; <http://inster39 dot ru/novosti/5976-raketchiki-na-pervykh-rubezhakh.html>
- 65 <https://mamasoldata dot mybb.ru/viewtopic.php?id=5031>; https://vk dot com/album-72814627_223391110; <https://www.newkaliningrad dot ru/news/community/1826048-balt-flot-vernul-voinskuyu-chast-beregovykh-raketchikov-v-poselok-donskoe.html>; <https://iz dot ru/680351/nikolai-surkov-aleksei-ramm-evgenii-dmitriev/poberezhe-rossii-prikryli-raketnye-monstry>
- 66 <https://ria dot ru/20170414/1492290493.html>; <https://www.rise dot md/rusa/%D0%B2%D0%B5%D1%80%D0%B1%D0%BE%D0%B2%D1%89%D0%B8%D0%BA%D0%B8-%D0%B8%D0%B7-%D1%80%D0%BE%D1%81%D1%81%D0%B8%D0%B9%D1%81%D0%BA%D0%BE%D0%B9-%D0%B0%D1%80%D0%BC%D0%B8%D0%B8-%D0%B2-%D0%BF%D1%80%D0%B8%D0%B4/>; https://monamir dot ru/%D0%9E%D0%BF%D0%B5%D1%80%D0%B0%D1%82%D0%B8%D0%B2%D0%BD%D0%B0%D1%8F_%D0%B3%D1%80%D1%83%D0%BF%D0%BF%D0%B0_%D1%80%D0%BE%D1%81%D1%81%D0%B8%D0%B9%D1%81%D0%BA%D0%B8%D1%85_%D0%B2%D0%BE%D0%B9%D1%81%D0%BA_%D0%B2_%D0%9F%D1%80%D0%B8%D0%B4%D0%BD%D0%B5%D1%81%D1%82%D1%80%D0%BE%D0%B2%D1%8C%D0%B5
- 67 <https://novostipmr dot com/old/2010/0188-03-10.html>; <https://fccland dot ru/stati/39699-82-y-otdelnyy-gvardeyskiy-motostrelkovyy-batalon.html>; https://vk dot com/wall-66283435_279849; <https://yablor dot ru/blogs/rossiyskaya-armiya-v-pridnestrove/5050984>
- 68 <https://forum-pmr dot net/showpost.php?p=288056&postcount=72>; https://vk dot com/wall10959367_3364
- 69 <https://m.ok dot ru/armiyas/topic/156108873518383>; <https://dzen dot ru/b/YmfTMEg6rX5msy7j>; <https://forum-pmr dot net/showpost.php?p=288056&postcount=72>; <https://life dot ru/p/1489856>
- 70 <https://web.archive.org/web/20210128051750/https://iz.ru/675176/evgenii-andreev-bogdan-stepovoi-aleksei-ramm/artilleriia-narashchivaet-moshch>; https://vk dot com/topic-126847421_35164521?offset=380; <https://mamasoldata.mybb dot ru/viewtopic.php?id=5195>
- 71 <https://web.archive.org/web/20200116091235/https://voinskayachast.net/suhoputnie-voyska/raketnie-i-artilleriya/vch53956>; <https://web.archive.org/web/20200116091239/https://tvernews.ru/news/122487/>; <https://vk dot com/club6465759>
- 72 <https://www.komandirovka dot ru/sights/naro-fo-minsk/202-ya-zenitnaya-raketnaya-brigada>; <http://old.adm-dzer dot ru/arxiv/250601/priziv.htm>
- 73 <https://army-today dot ru/wch/11262>; <https://voenchastrf dot ru/27-ia-otdelnaia-brigada-radiacionnoi-himicheskoi-i-biologicheskoi-zashity-v-ch-11262.html>
- 74 <https://iz dot ru/1113924/roman-kretcul/vzryvnaia-rabota-kak-nesut-sluzhbu-sovremennye-rossiiskie-sapery>; <https://army-today dot ru/wch/11105>
- 75 <https://army-today dot ru/wch/11361>; https://vk dot com/gvardeiskay_45_inganeray_brigada
- 76 <https://iz dot ru/1281617/aleksei-ramm-anton-lavrov-bogdan-stepovoi/v-epitcentre-tornado-iug-rossii-zashchitiat-raketno-artilleriiskie-roboty>; <https://iz dot ru/news/670561>; <https://iz dot ru/1278915/aleksei-ramm-roman-kretcul-bogdan-stepovoi/buk-vse-vidit-iug-rossii-prikryli-sovremennymi-kompleksami-pvo>
- 77 <https://prizivniku dot com/podrazdeleniya/150-motostrelkovaya-diviziya>; <https://iz dot ru/news/612939>; <https://iz dot ru/1156655/roman-kretcul-aleksei-ramm/teper-20-ia-legendarnoe-gvardeiskoe-soedinenie-vernetsia-v-stroi>; <https://informapalm.org/39397-150-ya-diviziya-xxi-veka-vs-rf-mify-i-realist/>
- 78 <https://vk dot com/polki02>; <http://www.don-kazak dot ru/news/102-y-motostrelkovyy-polk-kazachiy-polk/>
- 79 <https://active247 dot ru/kontraktniki/103-polok-ros-tov-na-donu.html>; <https://rostov dot nashpravka.ru/103-motostrelkovyy-polok-150-divizii-v-ch-91708-nomer-telefona-chasti-5193023>
- 80 https://vk dot com/wall-141481074_246; <https://novocherkassk.jsprav dot ru/voenkomyati-i-komissariatyi/v-ch-91714/>
- 81 https://ria dot ru/22033069-levkin_aleksei_vadimovich; <https://xn----8sbeyfcd4aauifcm dot xn--pai/wiki/1/3648/>
- 82 <https://8war dot ru/ipoteka/150-diviziya-novocherkassk.html>; <https://amalantra dot ru/150-motostrelkovaya-diviziya/>
- 83 <https://www.nvgazeta dot ru/news/14488/540281/>; <https://web.archive.org/web/20201028113600/http://vodorazdel-adm.ru/index.php/novosti-poseleniya/633-%C2%AB%D0%BE-%D0%BF%D0%BE%D1%80>

- %D1%8F%D0%B4%D0%BA%D0%B5-%D0%BA%D0%BE%D0%BC%D0%BF%D0%BB%D0%B5%D0%BA%D1%82%D0%BE%D0%B2%D0%B0%D0%BD%D0%B8%D1%8F-%D0%B2-2019-%D0%B3%D0%BE%D0%B4%D1%83-%D1%81%D0%BE%D0%B5%D0%B4%D0%B8%D0%BD%D0%B5%D0%BD%D0%B8%D0%B9-%D0%B8-%D0%B2%D0%BE%D0%B8%D0%BD%D1%81%D0%BA%D0%B8%D1%85-%D1%87%D0%B0%D1%81%D1%82%D0%B5%D0%B9-%D0%B2%D0%BE%D0%B5%D0%BD%D0%BD%D0%BE%D0%B3%D0%BE-%D0%BE%D0%BA%D1%80%D1%83%D0%B3%D0%B0,-%D0%B4%D1%80%D1%83%D0%B3%D0%B8%D1%85-%D0%B2%D0%BE%D0%B9%D1%81%D0%BA,-%D0%B2%D0%BE%D0%B8%D0%BD%D1%81%D0%BA%D0%B8%D1%85-%D1%84%D0%BE%D1%80%D0%BC%D0%B8%D1%80%D0%BE%D0%B2%D0%B0%D0%BD%D0%B8%D0%B9-%D0%B8-%D0%BE%D1%80%D0%B3%D0%B0%D0%BD%D0%BE%D0%B2-%D0%B2%D0%BE%D0%B5%D0%BD%D0%BD%D0%BE%D1%81%D0%BB%D1%83%D0%B6%D0%B0%D1%89%D0%B8%D0%BC%D0%B8,-%D0%BF%D1%80%D0%BE%D1%85%D0%BE%D0%B4%D1%8F%D1%89%D0%B8%D0%BC%D0%B8-%D0%B2%D0%BE%D0%B5%D0%BD%D0%BD%D1%83%D1%8E-%D1%81%D0%BB%D1%83%D0%B6%D0%B1%D1%83-%D0%BF%D0%BE-%D0%BA%D0%BE%D0%BD%D1%82%D1%80%D0%B0%D0%BA%D1%82%D1%83%C2%BB.html
- 84 <https://amalantra dot ru/150-motostrelkovaya-diviziya/>; <https://8war dot ru/ipoteka/150-diviziya-novocherkassk.html>
- 85 https://www.komandirovka dot ru/sights/millerovo/933-y-zenitnyiy-raketnyiy-polk/#anchor_nearest_objects; <https://m.ok dot ru/voyskovoep/album/59107419881523>; <https://iz dot ru/608604/aleksei-ramm-dmitrii-litovkin-evgenii-dmitriev/iug-rossii-usilili-zenitnymi-bublikami-avtomatami>
- 86 <https://web.archive.org/web/20211202015528/https://v1.ru/text/gorod/2021/12/01/70288448/>; https://web.archive.org/web/20210917015846/https://function.mil.ru/news_page/country/more.htm?id=12384277@egNews; <https://iz dot ru/1275278/2022-01-11/iug-rossii-prikryli-zenitnymi-robotami-avtomatami>; <https://iz dot ru/1156705/2021-04-25/minoborony-ukrepit-iuzhnye-rubezhi-20-i-motostrelkovoi-diviziei>
- 87 <https://vk dot com/club1598156?w=club1598156>; <https://vk dot com/club13063307?w=club13063307>; <https://web.archive.org/web/20211201105502/https://vpravda.ru/obshchestvo/v-volgograd-vozrodili-legendarnuyu-diviziyu-rossiyskoy-armii-123554/>
- 88 <https://web.archive.org/web/20220308161739/https://bloknot-volgograd.ru/news/na-ukraine-pogib-komandir-polka-iz-volgogradskoy-o-1454999>; https://web.archive.org/web/20220206111638/https://dictant.rgo.ru/dictant_place/32901
- 89 <https://urban3p dot ru/object15916#:~:text=944%2D%D0%B9%20%D1%81%D0%B0%D0%BC%D0%BE%D1%85%D0%BE%D0%B4%D0%BD%D1%8B%D0%B9%20%D0%B0%D1%80%D1%82%D0%B8%D0%BB%D0%BB%D0%B5%D1%80%D0%B8%D0%B9%D1%81%D0%BA%D0%B8%D0%B9%20%D0%A7%D0%B5%D1%80%D0%BD%D0%BE%D0%B2%D0%B8%D1%86%D0%BA%D0%BE%2D%D0%93%D0%BD%D0%B5%D0%B7%D0%BD%D0%B5%D0%BD%D1%81%D0%BA%D0%B8%D0%B9%20%D0%9A%D1%80%D0%B0%D1%81%D0%BD%D0%BE%D0%B7%D0%BD%D0%B0%BC%D1%81%D0%BD%D0%BD%D1%8B%D0%B9%2C,%D0%BF%D0%BE%D1%81%D1%81%D0%BB%D0%BA%D0%B5%20%D0%9C%D0%B0%D0%BA%D1%81%D0%B8%D0%BC%D0%B0%20%D0%93%D0%BE%D1%80%D1%8C%D0%BA%D0%BE%D0%B3%D0%BE%2C%20%D0%B3%D0%BE%D1%80%D0%BE%D0%B4%D0%B0%20%D0%92%D0%BE%D0%BB%D0%B3%D0%BE%D0%B3%D1%80%D0%B0%D0%B4%D0%B0>; <https://vk dot com/club32565602>
- 90 <https://bmpd.livejournal dot com/4397259.html>; https://vk dot com/wall-35660695_315482
- 91 <https://dzen dot ru/a/Yqhr6T9ogh0Zgg4F>; https://vk dot com/wall-210095549_16361
- 92 <https://altyn73 dot livejournal.com/1458271.html>; <https://vladimirkrym dot livejournal.com/11573592.html>; <https://twitter.com/halmiso1/status/1429386364580159495>
- 93 <https://altyn73 dot livejournal.com/1458271.html>; <https://vladimirkrym dot livejournal.com/11573592.html>; <https://twitter.com/halmiso1/status/1429386364580159495>
- 94 <https://amalantra dot ru/8-armiya-rossii/>
- 95 https://stpravda dot ru/20210807/vstavropole_49ya_obschevoyskovaya_armiya_yuvo_otmechaet_80yu_go_170759.html; <https://iz dot ru/1156655/roman-kretcul-aleksei-ramm/teper-20-ia-legendarnoe-gvardeiskoe-soedinenie-vernetsia-v-stroi>
- 96 <https://army-today dot ru/wch/74814>; <https://www.arms-expo dot ru/articles/armed-forces/poezdka-s-prizyvnikami-chast-vtoraya-v-205-y-brigade/>
- 97 <https://voinskajachast dot ru/sukhoputnye-voyska/motostrelkovye-voyska/vch-01485/>; <https://army-today dot ru/wch/01485>; <https://web.archive.org/web/20210127215524/https://zelpravda.ru/vlast/novym-komandirovka-34j-otdelnoj-motostrelkovoj-gornoj-brigady-naznachen-armii-polkovnik-sergej-dmitriev.html>
- 98 <https://rnbee dot ru/2017/04/28/7-ya-okkupatsionnaya-voennaya-baza-vs-rf-v-avangarde-rossijskoj-propagandy/>; <https://voinskajachast dot ru/sukhoputnye-voyska/motostrelkovye-voyska/vch09332/>; <https://iz dot ru/1215154/anton-lavrov-anna-cherapanova/pliazhnyi-zaslon-7-ia-voennaia-baza-poluchit-novye-vooruzheniia>; <https://vesb dot ru/kakie-voennye-chasti-est-v-abhazii>
- 99 https://desantura dot ru/forum/forum16/topic2404/?PAGE_I=2; <https://vechnayapamyat dot net/tag/19-%D1%80%D0%BE%D1%82%D0%B0-%D1%81%D0%BF%D0%B5%D1%86%D0%BD%D0%B0%D0%B7%D0%B0/>; <https://vpk dot name/images/i462249.html>
- 100 <https://iz dot ru/news/661691>; <https://topwar dot ru/109029-v-maykope-razvernuli-uboynuyu-artbrigadu.html>
- 101 <https://army-today dot ru/wch/31853>; <https://admiral55 dot ru/kontrakt/I-raketnaya-brigada-molkino.html>
- 102 <https://vk dot com/vch54821>; <https://www.itv dot ru/news/2017-03-07/321169-voennye-zenitno-raketnoy-brigady-yuzhnogo-voennogo-okruga-zaselyayut-novyy-mikrorayon-v-krasnodarskom-krae>
- 103 <https://region15 dot ru/proslavlennoj-58-j-armii-yuvo-ispolnyaetsya-25-let/>; <https://iz dot ru/1157009/2021-04-26/podrazdeleniia-58-i-armii-iuvo-vernulis-s-uchenii-v-krymu>
- 104 <http://vodorazdel-adm dot ru/index.php/novosti-poseleniya/633-%C2%AB%D0%BE-%D0%BF%D0%BE%D1%80%D1%8F%D0%B4%D0%BA%D0%B5-%D0>

- %BA%D0%BE%D0%BC%D0%BF%D0%BB%D0%B5%D0%BA%D1%82%D0%BE%D0%B2%D0%B0-%D0%BD%D0%B8%D1%8F-%D0%B2-2019-%D0%B3%D0%BE%D0%B4%D1%83-%D1%81%D0%BE%D0%B5%D0%B4%D0%B8%D0%BD%D0%B5%D0%BD%D0%B8%D0%B9-%D0%B8-%D0%B2%D0%BE%D0%B8%D0%BD%D1%81%D0%BA%D0%B8%D1%85-%D1%87%D0%B0%D1%81%D1%82%D0%B5%D0%B9-%D0%B2
%D0%BE%D0%B5%D0%BD%D0%BD%D0%BE%D0%B3%D0%BE-%D0%BE%D0%BA%D1%80%D1%83%D0%B3%D0%B0-%D0%B4%D1%80%D1%83%D0%B3%D0%B8%D1%85-%D0%B2%D0%BE%D0%B9%D1%81%D0%BA,-%D0%B2%D0%BE%D0%B8%D0%BD%D1%81%D0%BA-%D0%B8%D1%85-%D1%84%D0%BE%D1%80%D0%BC%D0%B8%D1%80%D0%BE%D0%B2%D0%B0%D0%BD%D0%B8%D0%B9-%D0%B8-%D0%BE%D1%80%D0%B3%D0%B0%D0%BD%D0%BE%D0%B2-%D0%B2%D0%BE%D0%B5%D0%BD%D0%BD%D0%BE%D1%81%D0%BB%D1%83%D0%B6%D0%B0%D1%89%D0%B8%D0%BC%D0%B8,-%D0%BF%D1%80%D0%BE%D1%85%D0%BE%D0%B4%D1%8F%D1%89%D0%B8%D0%BC%D0%B8-%D0%B2-%D0%BE%D0%B5%D0%BD%D0%BD%D1%83%D1%8E-%D1%81%D0%BB%D1%83%D0%B6%D0%B1%D1%83-%D0%BF%D0%BE-%D0%BA%D0%BE%D0%BD%D1%82%D1%80%D0%B0%D0%BA%D1%82%D1%83%D0%B8.html; https://iz dot ru/news/634572
- I05** <https://m.ok dot ru/group/55303559119024/topic/70039188747696>; <https://hanabihack dot ru/vc-3724.html>; <https://www.kavkazr dot com/a/komandovanie-motostrelkovogo-polka-iz-chechni-pytaetsya-skrytj-sabotazh-sredi-voennyh-v-ukraine/31859663.html>; http://42msd dot ru/index.php?option=com_content&task=view&id=16&Itemid=35
- I06** https://vk dot com/wall-75094478_10648
- I07** <https://vk dot com/8omsbr>; <https://www.warcechnya dot ru/vtoraya-chechenskaya-vojna-291-gv-msp-borzoj-shatojskij-rakon-2001-god/>; <https://www.kommersant dot ru/doc/1122573>; <https://iz dot ru/news/634572>
- I08** https://t.me/RKadyrov_95/2784; <https://groznyi dot bezformata.com/listnews/gorodok-polka-sever-ahmat/117013798/>; <https://ria dot ru/20220903/polka-1814221056.html>; <https://tass dot ru/armiya-i-opk/15638535>; <https://www.grozny-inform dot ru/news/express/141526/>
- I09** <https://donpress dot com/news/19-04-2022-zhite-li-rossii-nachinayut-chno-ponimat-i-massovo-otkazuyutsya-idi-voevat-v>; <https://mediavektor dot org/23461-v-vs-rf-nablyudaetsya-massovyj-otkaz-podpisyvat-novye-kontrakty-statistika.html>; <https://informnapalm dot org/47637-ustanovleny-personalnye-dannye-4-ros/>
- I10** https://posts24 dot ru/50-%D0%B9_%D0%B3%D0%B2%D0%B0%D1%80%D0%B4%D0%B5%D0%B9%D1%81%D0%BA%D0%B8%D0%B9_%D1%81%D0%B0%D0%BC%D0%BE%D1%85%D0%BE%D0%B4%D0%BD%D1%8B%D0%B9_%D0%B0%D1%80%D1%82%D0%B8%D0%BB%D0%BB%D0%B5%D1%80%D0%B8%D0%B9%D1%81%D0%BA%D0%B8%D0%B9_%D0%BF%D0%BE%D0%BB%D0%BA; <https://www.soldat dot ru/news/1996.html>;
- I11** https://vk dot com/wall-119776167_118169; <https://amalantra dot ru/42-diviziya/>
- I12** <https://amalantra dot ru/42-diviziya/>; [https://amalantra dot ru/42-diviziya/](https://xn--h1ajim dot xn--p1ai/index.php/42-%D1%8F_%D0%B3%D0%B2%D0%B0%D1%80%D0%B4%D0%B5%D0%B9%D1%81%D0%BA%D0%B0%D1%8F_%D0%BC%D0%BE%D1%82%D0%BE%D1%81%D1%80%D0%B5%D0%BB%D0%BA%D0%BE%D0%B2%D0%B0%D1%8F_%D0%B4%D0%B8%D0%B2%D0%B8%D0%B7%D0%B8%D1%8F); https://xn--h1ajim dot xn--p1ai/index.php/42-%D1%8F_%D0%B3%D0%B2%D0%B0%D1%80%D0%B4%D0%B5%D0%B9%D1%81%D0%BA%D0%B0%D1%8F_%D0%BC%D0%BE%D1%82%D0%BE%D1%81%D1%80%D0%B5%D0%BB%D0%BA%D0%BE%D0%B2%D0%B0%D1%8F_%D0%B4%D0%B8%D0%B2%D0%B8%D0%B7%D0%B8%D1%8F
- I13** https://vk dot com/vladikavkaz_190mcbp; <https://voinskajachast dot ru/sukhoputnye-voyska/motostrelkovye-voyska/vch20634/>; <https://war-proekt.media/base/voiska/19-motostrelkovaya-voronezhsko-shumlinskaya-diviziya/>
- I14** <https://rus-osetia dot ru/archives/vladikavkazskij-429-motostrelkovyj-polk-58-oj-armiya-voshel-v-perechen-soedinenij-podlezhashhih-komplektovaniyu-chlenami-terskogo-vojskovogo-kazachego-obshhestva/>; <https://konsaltdo dot ru/429-motostrelkovyj-polk-vch-01860-pos-sputnik-vladikavkaz.html>
- I15** <https://army-today dot ru/wch/75394>; <https://t.me/mobilizationnews/10583>; <https://pomnirod dot ru/materi-aly-k-statyam/rossiya-poslerevolucionnaya/voennye/voinskije-podrazdeleniya/motostrelkovye-brigady/22-ya-motostrelkovaya-brigada/obshhie-svedeniya-o-22-j-motostrelkovoj-brigade.html>
- I16** <https://yandex dot ru/video/preview/4329711854617529105>; <https://iz dot ru/843842/2019-02-09/smi-soobshchili-ob-usilenii-voisk-rf-na-iuge-dvumia-diviziiami>
- I17** <https://army-today dot ru/wch/66431>; <https://voenchastrf dot ru/4-gvardeiskaia-voennaia-baza-v-ch-66431.html>; <https://mamasoldata.mybb dot ru/viewtopic.php?id=1223>
- I18** <https://voenchastrf dot ru/100-ia-otdelnaia-razvedyvatelnaia-brigada-v-ch-23511.html>; <https://army-today dot ru/wch/23511>
- I19** <https://army-today dot ru/wch/64670>; <https://voenchastrf dot ru/291-ia-artilleriiskaia-brigada-v-ch-64670.html>
- I20** https://dzen dot ru/a/YoPKkT4WaXSy_fm; https://vk dot com/wall10959367_3116
- I21** <https://amalantra dot ru/chernomorskiy-flot-rossii/>; <https://www.kchf dot ru/>
- I22** <https://ria dot ru/20170210/1487713296.html>; <https://iz dot ru/1061014/anton-lavrov-roman-kretcul/krymskii-post-poluostrov-zashchitit-dalnoboinaia-artilleriia>; <https://sprotyv dot info/analitica/v-krymu-razvernuta-boegotovaya-krupnaya-amfibijnaya-gruppirovka-vojsk-agressora-koordinator-is/>
- I23** <https://ru.krymr dot com/a/chernomor-skiy-flot-rossii-126-ya-brigada-nastroyeniya-poteri-ukraina-vojna/31965995.html>; <https://iz dot ru/1189394/roman-kretcul-anna-cherapanova/tank-tochnyi-oboronu-kryma-usiliat-sverkhzashchishchennymi-t-72b3m>; <https://yandex dot ru/maps/org/126-ya-otdelnaya-brigada-beregovoy-oborony/184406181128/?ll=34.338212%2C44.847716&z=13.86>
- I24** <https://osnaz-cikle dot livejournal.com/221591.html>; https://vk dot com/wall-52075449_4850; <https://iz dot ru/852398/dmitrii-boltenkov/krymskii-bastion-kak-izmenilas-voennaia-infrastruktura-poluostrova>
- I25** <https://informnapalm dot org/50142-8-j-otdelnyj-artil-lerijskij-polk-chf-rf/>; <https://www.kommersant dot ru/doc/4530832>; <https://ru.krymr dot com/a/voyenny-ye-krym-vojna-gvardiya-poteri/32488985.html>
- I26** https://vk dot com/album-72814627_223392300; <https://nts-tv dot com/news/v-15-y-otdelnoy-beregovoy-brigade-chf-proveli-den--22960/>
- I27** <https://octagon dot media/vojna/morskaya-brigada.html>; <https://army-today dot ru/wch/13140>

- 128 https://vk dot com/wall94808902_2515; <https://arsenal-info dot ru/b/book/1881647449/49>; <https://www.kommersant dot ru/doc/3867782>
- 129 <https://army-today dot ru/roda/beregovye-vojska-vmf>; <https://flot2017 dot com/okkupanty-strelyali-v-krymu/>; <https://voinskayachast dot net/voenno-morskoj-flot/coastal-troops-navy>
- 130 <https://topwar dot ru/3086-chernomorskij-flot-poluchil-tretij-bastion.html>; https://nvo.ng dot ru/forces/2020-03-06/3_1084_coastguard.html; <https://dzen dot ru/a/YmBjxcj60SoYfABL>
- 131 <https://ria dot ru/20210826/kaspiysk-1747313526.html>; <https://ria dot ru/20221115/flotiliya-1831346559.html>
- 132 <https://vechnayapamyat dot net/tag/177-%D0%B9-%D0%BF%D0%BE%D0%BB%D0%BC%D0%BE%D1%80%D1%81%D0%BA%D0%BE%D0%B9-%D0%BF%D0%B5%D1%85%D0%BE%D1%82%D1%8B-%D0%BA%D0%Bo%D1%81%D0%BF%D0%B8%D0%B9%D1%81%D0%BA/>; https://web.archive.org/web/2020013072611/https://function.mil.ru/for_media/events/details.htm?id=5826@morfSimpleEvent
- 133 <https://bmpd.livejournal dot com/3927068.html>; <https://topwar dot ru/172772-usilenie-morskoj-pehoty-kaspijskoj-flotilii.html>; https://vk dot com/wall-72814627_155116
- 134 <https://www.kavkaz-uzel dot eu/articles/152315>; https://vk dot com/voennaya_baza?w=club14347137; <https://topwar dot ru/181270-rossijskie-bazy-za-rubezhom-102-ja-baza-v-gjumri.html>; <https://ru.armeniasputnik dot am/102-russia-voennaja-baza-gumri/>
- 135 <https://ok dot ru/voyskovoep/album/56825385123891>; <https://fb dot ru/article/257705/voennaya-baza-ya-rossiyskaya-voennaya-baza-v-gyumri-armeniya>
- 136 <https://vk dot com/club28149279>; <https://orbitaznamensk dot ru/articles/society/2022-10-08/komandir-znamenskoy-artillerijskoj-brigady-rasskazal-o-budnyah-boevogo-podrazdeleniya-108108>
- 137 <https://dzen dot ru/b/ZB8jiferYDRvDzms>; <https://korvesti dot ru/novosti/obshchestvo/14904-korenovskoj-77-j-zenitnoj-raketnoj-brigade-prisvoeno-naimenovanie-gvardejskoj>
- 138 <https://arum74 dot ru/srochnaya/inzhenernye-vojska-kamensk-shahtinskij.html>; <https://mamasoldata.mybb dot ru/viewtopic.php?id=500>; <https://m.ok dot ru/vch45767g>
- 139 <https://army-today dot ru/wch/65363>; <https://voinskiechasti dot ru/suhoputnie-voyska/specialnie/vch65363>
- 140 <https://geraldika dot ru/s/20232>; <https://iz dot ru/770683/2018-07-25/v-sibiri-bolee-10-tysiach-voennoslu-zhashchikh-podniali-po-trevoge>
- 141 <https://vv-mvd dot ru/mo/tankovye/90-tankovaya-diviziya-chebarkul.html>; <https://voinskaya-chast dot ru/vooruzhennye-cily/tankovye-vojska/voinskaya-chast-89547-chebarkul.html>
- 142 <https://74 dot ru/text/gorod/2022/07/04/71460047/>; <https://www.chel.kp dot ru/daily/27413/4612324/>
- 143 https://vk dot com/wall-211936157_22091; <https://pomnirod dot ru/materialy-k-statyam/rossiya-poslerevolucionnaya/voennye/voinskie-podrazdeleniya1/tankisty/tankovye-divizii/90-ya-gvardejskaya-tankovaya-vitebsko-novgorodskaya-dvazhdy-krasnoznamyonnaya-diviziya/sostav-90-j-gvardejskoj-tankovoj-divizii-na-2018-god/6-j-gvardejskoj-tankovoj-divizii-obshhie-svedeniya-o-6-j-gvardejskom-tankovom-polku.html>
- 144 <https://pomnirod dot ru/materialy-k-statyam/rossiya-poslerevolucionnaya/voennye/voinskie-podrazdeleniya1/tankisty/tankovye-divizii/90-ya-gvardejskaya-tankovaya-vitebsko-novgorodskaya-dvazhdy-krasnoznamyonnaya-diviziya/sostav-90-j-gvardejskoj-tankovoj-divizii-na-2018-god/80-j-tankovyy-krasnoznamyonnij-polk-v-ch-87441-90-j-gvardejskoj-tankovoj-divizii-obshhie-svedeniya-o-80-j-tankovom-krasnoznamyonom-polku-90-j-gvardejskoj-tankovoj-divizii.html>; <https://up74 dot ru/articles/news/141807/>
- 145 <https://vk dot com/brigada22316>; <https://vechnayapamyat dot net/tag/228-%D0%B9-%D0%BC%D0%BE%D1%82%D0%BE%D1%81%D1%82%D1%80%D0%B5%D0%BB%D0%BA%D0%BE%D0%B2%D1%8B%D0%B9-%D0%BF%D0%BE%D0%BB%D0%BA/>; <https://eanews dot ru/news/motostrelkovyy-polk-iz-yekaterinburga-za-massovyy-geroizm-poluchil-zvaniye-gvardejskogo-dokument-14-02-2023>; <https://vremya dot press/228-0j-motostrelkovyy-polk-iz-ekaterinburga-stal-gvardejskim/>
- 146 <https://ura dot news/news/1052581345>; <https://konsultantok dot ru/chebarkulskaya-tankovaya-diviziya.html>
- 147 <https://74 dot ru/text/gorod/2022/10/17/71742896/>; https://polit74 dot ru/society/400_y_artillerijskiy_polk_poluchivshiy_zvanie_gvardejskiy_imeet_slavnuyu_istoriyu/
- 148 [https://armiyapro dot ru/srochnaya-sluzhba/vojskovaya-chast-41659-35-ya-omsbr#:~:text=%D0%9C%D0%BE%D1%82%D0%BE%D1%81%D1%82%D1%80%D0%B5%D0%B%D0%BA%D0%BE%D0%B2%D0%Bo%D1%8F%20%D0%B1%D1%80%D0%B8%D0%B3%D0%Bo%D0%B4%D0%Bo%2035%2D%D0%B3%D0%BE%20%D0%BE%D1%82%D1%80%D1%8F%D0%B4%D0%Bo%20%D0%BE%D1%80%D0%B4%D0%B5%D0%BD%D0%BE%D0%B2,%D0%BD%D0%Bo%D0%B8%D0%BC%D0%B5%D0%BD%D0%BE%D0%B2%D0%Bo%D0%BD%D0%B8%D0%B5%20%D1%87%D0%Bo%D1%81%D1%82%D0%B8%20\(%D1%83%D1%82%D0%BE%D1%87%D0%BD%D0%B8%D1%82%D1%8C%20%D1%83%20%D1%81%D0%BE%D0%BB%D0%B4%D0%Bo%D1%82%D0%Bo\);](https://armiyapro dot ru/srochnaya-sluzhba/vojskovaya-chast-41659-35-ya-omsbr#:~:text=%D0%9C%D0%BE%D1%82%D0%BE%D1%81%D1%82%D1%80%D0%B5%D0%B%D0%BA%D0%BE%D0%B2%D0%Bo%D1%8F%20%D0%B1%D1%80%D0%B8%D0%B3%D0%Bo%D0%B4%D0%Bo%2035%2D%D0%B3%D0%BE%20%D0%BE%D1%82%D1%80%D1%8F%D0%B4%D0%Bo%20%D0%BE%D1%80%D0%B4%D0%B5%D0%BD%D0%BE%D0%B2,%D0%BD%D0%Bo%D0%B8%D0%BC%D0%B5%D0%BD%D0%BE%D0%B2%D0%Bo%D0%BD%D0%B8%D0%B5%20%D1%87%D0%Bo%D1%81%D1%82%D0%B8%20(%D1%83%D1%82%D0%BE%D1%87%D0%BD%D0%B8%D1%82%D1%8C%20%D1%83%20%D1%81%D0%BE%D0%BB%D0%B4%D0%Bo%D1%82%D0%Bo);) <https://army-today dot ru/wch/41659>
- 149 <https://army-today dot ru/wch/21005>; <https://voinskajachast dot ru/sukhoputnye-voyska/motostrelkovye-voyska/vojskovaya-chast-21005-74-ya-otdelnaya-gvard/>; <https://vk dot com/club149010323>
- 150 <https://zolord dot ru/news/434>; <https://topwar dot ru/175707-budni-otdelnoj-motostrelkovoj-gornoj-brigady-v-respublike-tuva.html>
- 151 <https://voenchastrf dot ru/120-ia-artilleriiskaia-brigada-v-ch-59361.html>; <https://army-today dot ru/wch/59361>
- 152 <https://army-today dot ru/wch/49547>; <http://forum.IITd dot ru/lofiversion/index.php/t8223.html>; <https://interesnoe dot me/view/content/upd/22597841>
- 153 <https://2gis dot ru/search/%D0%A8%D1%82%D0%Bo%D0%B1%202%20%D0%Bo%D1%80%D0%BC%D0%B8%D0%B8?m=50.38401%2C52.770723%2F7.57>; <https://voin-box dot ru/sluzhba/shtab-armii-samara.html>; <https://63 dot ru/text/gorod/2016/09/24/56313181/>

- 154 <https://web.archive.org/web/20210125001005/https://prizyvnik-soldat.ru/vch-45863-roshchinskij/>; <https://armiyapro dot ru/srochnaya-sluzhba/30-motostrelkovaya-brigada-30-msbr/>; <https://m.ok.ru/avspoligon/topic/151492464420903>
- 155 <https://tass dot ru/politika/14599617/>; <https://army-today dot ru/wch/90600/>; <https://amalantra dot ru/15-brigada-chernyye-gusary/>
- 156 <https://web.archive.org/web/20171211233758/http://voinskaya-chast.ru/vooruzhennye-cily-cuxoputnye-vojska/motostrelkovye-vojska/voinskaya-chast-12128-21-gvardejskaya-motostrelkovaya-brigada.html>; <https://army-today dot ru/wch/12128>
- 157 <https://army-today dot ru/wch/32755/>; <https://aldamuratova dot ru/na-kontrakte/vch-30785.html>
- 158 <https://ok dot ru/group/43862559359115/album/51214000521355?st.cmd=anonymGroupAlbumPhotos&st.groupId=43862559359115&st.albumId=51214000521355>; <https://vk dot com/artillerists>
- 159 <https://mamasoldata.mybb dot ru/viewtopic.php?id=770/>; <https://urban3p dot com/object16969>
- 160 <https://voinskichasti dot ru/vozdushno-kosmicheskiesily/voenno-vozdushnie-sily/zrv/vch02030/>; <https://armiyapro dot ru/srochnaya-sluzhba/voinskaya-chast-02030-297-ya-zrb-mestonahozhdenie-kontakty>
- 161 <https://pobedarf dot ru/2023/06/02/yubilej-voennoj-bazy-otmetili-v-srednej-azii/>; <https://www.asiaplustj dot info/ru/news/tajikistan/society/20221202/v-rossiiskoi-voennoi-baze-v-tadzhikistane-smenilsya-rukovoditel/>; <https://yandex dot ru/video/preview/15898689740161240572/>; <https://tj.sputniknews dot ru/20230601/dushanbe-201-rvb-1057490501.html>
- 162 <https://post1 dot su/holodnoe/201-ya-rossijskaya-voennaya-baza-2.html>; <https://pomnirod dot ru/materialy-k-statyam/rossiya-poslerevolucionnaya-voennye-voinskije-podrazdeleniya/1-ya-gvardejskaya-strelkovaya-diviziya/201-ya-motostrelkovaya-diviziya/92-j-motostrelkovyj-polk-201-j-motostrelkovoj-divizii/obshhie-svedeniya-o-92-m-motostrelkovom-polku-201-j-motostrelkovoj-divizii.html>; <https://rus.ozodi dot org/a/27374340.html>
- 163 <https://army-today dot ru/wch/31643/>; <https://www.chel.kp dot ru/daily/27464/4670511/>
- 164 <https://dzen dot ru/a/Xbj39deFmwCx6Yma>; <https://topwar dot ru/104777-v-kirovskoy-oblasti-zastupila-na-boevoe-dezhurstvo-zenitnaya-raketnaya-brigada.html>
- 165 <https://www.komandirovka dot ru/sights/shihani/1-ya-mobilnaya-brigada-rhb-zaschityi/>; <https://ext-5787874.livejournal dot com/9455.html>; <https://mamasoldata.mybb dot ru/viewtopic.php?id=4616&p=2>
- 166 <https://mamasoldata.mybb dot ru/viewtopic.php?id=4103/>; <https://aldamuratova dot ru/sluzhba/v-ch-41158-ekaterinburg.html>; https://vk dot com/rhbz_ekaterinburg/; <https://army-today dot ru/wch/34081>
- 167 <https://www.ufa.kp dot ru/daily/26632/3655160/>; <https://army-today dot ru/wch/63494>
- 168 <https://xn--80adjlackxh6aem6d dot xn--p1ai/chast/06426/>; https://vk dot com/wall303798627_3/; <https://amalantra dot ru/5-armiya-rossii/>; <https://prizivniku dot com/voenchast/voinskije-chasti-ussuriyska>
- 169 <https://vk dot com/club20025044/>; <https://prizivniku dot com/voenchast/voinskaya-chast-44980-sergeevke>
- 170 <https://vladivostok dot nashaspravka.ru/moy-syn-sluzhit-v-394-motostrelkovom-polku-v-ch-25573-s-sergeevka-primorskogo-kraya-v-dannyy-moment-nahoditsya-na-uchebnom-poligone-i-on-bolen-pomosch-nikto-ne-okazyvaet-k-komubratitsya-5337816/>; <https://www.soldat dot ru/news/1325.html>
- 171 <https://vk dot com/club34419435/>; https://vk dot com/wall-33314801_88705
- 172 <https://m.ok dot ru/dalnik/topic/69413990968086/>; https://vk dot com/topic-20025044_3966185
- 173 <https://akrasdia dot ru/podborki/218-tankovyj-polk-sergeevka-95-foto.html>; <http://wikimapia dot org/5864922/ru/218-%D0%B9-%D1%82%D0%B0%D0%BD%D0%BA%D0%BE%D0%B2%D1%8B%D0%B9-%D0%BF%D0%BE%D0%BB%D0%BA-%D0%B2-%D1%87-82588-%D0%B8-79-%D0%B9-%D0%BE%D1%82%D0%B4%D0%B5%D0%BB%D1%8C%D0%BD%D1%8B%D0%B9-%D1%80%D0%B5%D0%BC%D0%BE%D0%BD%D1%82%D0%BD%D0%BE-%D0%B2%D0%BE%D1%81%D1%81%D1%82%D0%B0%D0%BD%D0%BE%D0%B2%D0%B8%D1%82%D0%B5%D0%BB%D1%8C%D0%BD%D1%8B%D0%B9-%D0%B1%D0%B0%D1%82%D0%B0%D0%BB%D1%8C%D0%BE%D0%BD-%D0%B2-%D1%87-98655>
- 174 https://m.vk dot com/wall-20025044_24873?lang=en; <https://m.ok dot ru/profile/830275035/statuses/68034254332123>
- 175 <https://ok dot ru/voyskovep/album/57197589692467/>; https://vk dot com/wall-11349899_226222
- 176 <https://web.archive.org/web/20171230060134/https://svpressa.ru/society/article/34815/>; <https://vk dot com/club126221638/>; <https://army-today dot ru/wch/46102>
- 177 <https://army-today dot ru/wch/39255/>; <https://xn--80adjlackxh6aem6d dot xn--p1ai/chast/vch-39255/>
- 178 <https://yandex dot ru/video/preview/5010020587076388375/>; <https://xn--80adjlackxh6aem6d dot xn--p1ai/chast/vch-92088-chast-rasformirovana/>
- 179 <https://tass dot ru/obschestvo/8804509/>; [https://iz dot ru/1013941/anton-lavrov-roman-kretcul/kalashnyi-podriad-dalnevostochnykh-voennykh-vooruzhat-noveishim-avtomatom](https://iz dot ru/1013941/anton-lavrov-roman-kretcul/kalashnyi-podriad-dalnevostochnykh-voennykh-vooruzhat-noveishim-avtomatom;); <https://dzen dot ru/a/YqxEMfDpcWqKJPsw>
- 180 <https://www.svoboda dot org/a/lichnogo-sostava-pochtine-suschestvuet-konets-brigady-iz-buchi/31981821.html>; <https://army-today dot ru/wch/51460/>; <https://voinskajachast dot ru/sukhoputnye-voyska/motostrelkovye-voyska/v-ch-51460-mlechnik-64-aya-omsbr/>; <https://topwar dot ru/195125-64-j-otdelnoj-motostrelkovoj-brigade-prisvoeno-pochetnoe-zvanie-gvardejskaja.html>
- 181 <https://iz dot ru/885405/aleksei-ramm-bogdan-stepovoi/vystrely-amura-noveishie-tanki-t-80-otpravilis-na-dalnii-vostok/>; <https://voinskayachast dot net/suhoputnie-voyska/motostrelkovie/vch21720/>; <https://army-today dot ru/wch/21720>
- 182 <https://vk dot com/club39381127/>; <https://voenchastrf dot ru/69-ia-otdelnaia-kazachia-brigada-prikrytiia-v-ch-61424.html>
- 183 <https://army-today dot ru/wch/02901/>; <https://m.ok dot ru/group/54363881209927/topic/156185813112135>
- 184 <https://livebir dot ru/lietnii-pieriod-obuchieniia-nachalsia-dlia-voienosluzhashchikh-v-birobidzhanie/>; <https://army-today dot ru/wch/47062>

- 185 <https://army-today dot ru/wch/01879>; <https://dzen dot ru/b/ZB8o1YY7mwmDx4LB>; <https://m.ok dot ru/group/51804449669322/topic/155729751469002>
- 186 <https://iz dot ru/605401/2017-06-13/zenitno-raketnye-chasti-na-dalnem-vostoke-perevoorzhaiut-noveishimi-buk-m3>; <https://iz dot ru/604547/aleksei-ramm-dmitrii-litovkin-nikolai-surkov/dalnii-vostok-prikryli-bukami>
- 187 <https://army-today dot ru/wch/69647>; <https://vk dot com/topic-69658298-35747692>
- 188 <https://army-today dot ru/wch/46108>; <https://petrimazepa dot com/fifth.html>; <https://vk dot com/wall-304573-52158>; <https://iz dot ru/news/650874>
- 189 <https://ok dot ru/v.ch.62048/topic/66291825497427>; <https://mamasoldata mybb.ru/viewtopic.php?id=4374>
- 190 <https://m.ok dot ru/voennoprom/topic/64014897954990>; https://vk dot com/wall-100861506_182181
- 191 <https://iz dot ru/news/650874>; <https://vk dot com/wall-77451915-116135>
- 192 <https://www.chita dot ru/text/society/2023/05/09/72288491/>; <https://www.chita dot ru/text/society/2023/01/07/71955542/>; <https://www.chita dot ru/text/society/2022/10/25/71763761/>; <https://www.chita dot ru/text/society/2022/09/13/71649851/>; <https://prizivniku dot com/voenchast/voinskije-chasti-chite>
- 193 <https://army-today dot ru/wch/06705>; <https://voinskaja-chast dot ru/sukhoputnye-voyska/motostrelkovye-voyska/vch06705-borzya/>
- 194 <https://baikal24 dot ru/text/07-09-2019/024/>; <https://gorodarus dot ru/gornyj.html>
- 195 <https://baikal24 dot ru/text/07-09-2019/024/>; <https://gorodarus dot ru/gornyj.html>
- 196 <https://gtrkchita dot ru/news/vesti-24181/parad-dlia-edinstvennogo-veterana-sela-ustroila-140-zenitno-raketnaia-brigada-v-domne/>; <http://safe-rgs dot ru/270-140-zenitno-raketnaya-brigada-iz-polshi-cherez-kazahstan-v-zabaykale.html>
- 197 <https://xn--80adjlackxh6aem6d dot xn--p1ai/chast/62665/>; <https://www.rusprofile dot ru/id/7338537>; <https://checko dot ru/company/fku-voyskovaya-chast-62665-1092536010489>
- 198 <https://iz dot ru/1103734/anton-lavrov-roman-kretcul-s-korablia-napal-dalnevostochnye-morpekhi-poluchat-tiazheluiu-bronetekniku>; <https://prizivniku dot com/podrazdeleniya/155-brigada-morskoy-pehoty>
- 199 <https://army-today dot ru/wch/10103>; <https://voinskaya-chast dot ru/vooruzhennye-cily/voenno-morskoj-flot/beregovye-vojska/voinskaya-chast-10103-petropavlovsk-kamchatskij.html>
- 200 <https://primamedia dot ru/news/522062/>; <https://nstarikov dot ru/legenda-o-holuae-istorija-samoj-sekretnoj-chasti-morskogo-specnaza-tihookeanskogo-flota-109683>
- 201 <https://army-today dot ru/roda/beregovye-vojska-vmf>; https://nvo.ng dot ru/nvoexpert/2019-10-11/7_1065_defence.html
- 202 https://vk dot com/kamchatka_morskai_pecgota; <https://topwar dot ru/9357-strelby-520-y-beregovoy-raketno-artilleriyskoy-brigady.html>
- 203 <https://iz dot ru/1271796/dmitrii-boltenkov/s-bala-na-korabl-minoborony-perevooruzhit-raketchikov>; <https://anna-news dot info/beregovaya-raketnaya-brigada-razvyornuta-na-sahaline/>
- 204 <https://iz dot ru/1079266/roman-kretcul-aleksei-ramm/do-kuril-na-tanke-ostrova-usiliat-noveishimi-boevymi-mashinami>; <https://vk dot com/68armycorp>
- 205 <https://informnapalm dot org/4981-gosty-s-sahalyna-18-yapulad/>; <https://topwar dot ru/187052-rossijskoe-voennoe-priustsvie-na-kurilskih-ostrovah.html>
- 206 <https://vk dot com/wall-4648439-3442>; <https://voenchastrf dot ru/46-i-pylemetno-artilleriiskii-polk-v-ch-71435.html>
- 207 <https://prizivaut dot ru/voinskije-chasti/yuzhno-saxalinska-i-saxalinskoj-oblasti.html#:~:text=49%2D%D0%B9%20%D0%BF%D1%83%D0%BB%D0%B5%D0%BC%D0%B5%D1%82%D0%BD%D0%BE%2D%D0%B0%D1%80%D1%82%D0%B8%D0%BB%D0%BB%D0%B5%D1%80%D0%B8%D0%B9%D1%81%D0%BA%D0%B8%D0%B9%20%D0%BF%D0%BE%D0%BB%D0%BA.%20694541%2C%20%D0%A1%D0%B0%D1%85%D0%B0%D0%BB%D0%B8%D0%BD%D1%81%D0%BA%D0%B0%D1%8F,%D0%9A%D0%BB%D1%8E%D1%87%D0%B8%2C%20%D0%BE%2D%D0%B2%20%D0%98%D1%82%D1%83%D1%80%D1%83%D0%BF%2C%20%D0%B2%2F%D1%87%2036869>; https://sakhalin-znak dot ru/sahalin/army/IMG_240_04.2020
- 208 <https://army-today dot ru/wch/35390>; <https://voinskaya-chast dot ru/vooruzhennye-cily/cuxoputnye-vojska/motostrelkovye-vojska/voinskaya-chast-35390-39-ya-motostrelkovaya-brigada.html>; <https://mail-katalog dot ru/numbers/telefon-otdela-kadrov-vch-35390.html>
- 209 https://vk dot com/wall-41196400_4888; [https://monamir dot ru/68-%D0%B9-%D0%B0%D1%80%D0%BC%D0%B5%D0%B9%D1%81%D0%BA%D0%B8%D0%B9_%D0%BA%D0%BE%D1%80%D0%BF%D1%83%D1%81\(%D0%A0%D0%BE%D1%81%D1%81%D0%B8%D1%8F\)](https://monamir dot ru/68-%D0%B9-%D0%B0%D1%80%D0%BC%D0%B5%D0%B9%D1%81%D0%BA%D0%B8%D0%B9_%D0%BA%D0%BE%D1%80%D0%BF%D1%83%D1%81(%D0%A0%D0%BE%D1%81%D1%81%D0%B8%D1%8F)); <https://artgallery72 dot ru/pistolet/ierarhiya-armii.html>
- 210 <https://army-today dot ru/wch/57367>; <https://newsland dot com/post/5107958-garnizon-lesnaia-31>
- 211 <https://altyn73 dot livejournal.com/1423382.html>; <http://ptichnik dot com/index.php/14-sample-data-articles/1180-zashchita-interesov-nashego-mnogonatsionalnogogosudarstva>
- 212 <https://dzen dot ru/a/X8h6MOuVpTc0916B>; <https://ok dot ru/group/53660815261875/topic/154331976887731>
- 213 <https://arum74 dot ru/srochnaya/komsomolsk-na-amure-voinskaya-chast.html>; <https://army-today dot ru/wch/30763>; <https://voinskajachast dot ru/sukhoputnye-voyska/specialnye-voyska/vch-30763-14-aya-inzhenernaya-brigada/>
- 214 <https://ooartur dot ru/budni/severomorsk-chast-vmf.html>; <https://murman-zan dot ru/employer/detail/?companyId=b0a0b139-7be8-4c3e-bd8d-1d6e7f20d0c7>
- 215 <https://russian.rt dot com/russia/article/1010011-severnyi-flot-rossiya>; <https://web.archive.org/web/20200420234438/>; <https://structure.mil.ru/structure/okruga/north/history.htm>
- 216 <https://iz dot ru/news/681638>; <https://vk dot com/club884374>
- 217 <https://iz dot ru/news/681638>; <https://thebar-entsobserver dot com/ru/bezopasnost/2023/02/arkticheskaya-brigada-iz-alakurtti-podschityaet-pogibshih>
- 218 <https://voinskajachast dot ru/voenno-morskoy-flot/beregovye-voyska/v-ch-38643-sputnik-61-obrmp/>; <https://amalantra dot ru/61-brigada-morskoy-pehoty/>

- 219 <https://xn--90aukhw dot xn--p1ai/specnaz-vmf-ros-sii-morskije-razvedyvatelnye-punkty/>; <https://milita.jofo dot me/1814412.html>
- 220 https://vk dot com/olenya_gyba10544; <https://topwar dot ru/169112-beregovaja-oborona-v-sovremennom-mire-nove-jshaja-istorija.html>
- 221 <https://stilin dot ru/stati/12298-severnny-flot-vmf-rossii.html>; <https://vk dot com/wall-93188324-47031>
- 222 <https://russian.rt dot com/russia/article/692696-vdv-gor-naya-diviziya-novorossiisk>; <https://iz dot ru/1018883/anton-lavrov-roman-kretcul/vozdushno-morskije-voiska-desant-gotoviat-dlia-vysadki-s-korablei>
- 223 https://aif dot ru/society/army/nikto_krome_v_krymu_razvernut_polk_vdv; <https://topwar dot ru/188301-novyj-desantno-shturmovoij-polk-usilit-oboronu-kryma.html>
- 224 <https://army-today dot ru/wch/42091>; <https://voinska-jachast dot ru/vozdushno-desantnye-voyska/108-y-gvardejskiy-desantno-shturmovoij-pol/>; <https://voenchas-trf dot ru/108-i-gvardeiskii-desantno-shturmovoij-polk-v-ch-42091.html>; <https://prizivniku dot com/podrazdeleniya/108-polk-vdv-g-novorossiyske>
- 225 <https://army-today dot ru/wch/54801>; <https://vechnay-apamyat dot net/tag/247-%D0%B9-%D0%B3%D0%B2%D0%B0%D1%80%D0%B4%D0%B5-%D0%B9%D1%81%D0%BA%D0%B8%D0%B9-%D0%B4%D0%B5%D1%81%D0%B0%D0%BD%D1%82%D0%BD%D0%BE-%D1%88%D1%82%D1%83%D1%80%D0%BC%D0%BE%D0%B2%D0%BE%D0%B9-%D0%BF%D0%BE%D0%BB/>; <https://aldamuratova dot ru/sluzhba/vdv-stavropol.html>
- 226 <https://crimea.ria dot ru/20171202/1112978114.html>; <https://www.crimea.kp dot ru/daily/26765.7/3797742/>; <https://bmpd.livejournal dot com/2985671.html>
- 227 https://vk dot com/wall-106160452_161505; <https://pomnirod dot ru/materialy-k-statyam/rossiya-poslerevolucionnaya/voennye/voinskie-podrazdeleniya1/desantura/127-ya-gvardejskaya-strelkovaya-diviziya/7-ya-gvardejskaya-vozdushno-desantnaya-diviziya/obshhie-svedeniya-o-7-j-gvardejskoj-vozdushno-desantnoj-divizii.html>
- 228 https://vk dot com/wall-147867120_7923; <https://amalantra dot ru/7-diviziya-vdv/>
- 229 <https://anapa-ch dot ru/s-dnyom-vdv-zamnachalnika-shtaba-1141-go-artpolka-o-boevyx-budnyax-anapskix-desantnikov/>; <https://avangard-nk dot ru/sluzhba/diviziya-vdv-anapa.html>
- 230 <https://vfront dot ru/samolety/4-armiya-vvs-i-pvo-sostav.html>; <https://vitjko dot livejournal.com/55301.html>
- 231 <https://m.ok dot ru/voyskovoep/album/57782063530035>; <https://xn--80adjlackxh6aem6d dot xn--p1ai/chast/94021/>
- 232 <https://amalantra dot ru/76-diviziya-vdv/>; <https://vk dot com/komdiv76>; <https://voenpro dot ru/infolenta/flag-vdv-76-gvardejskaya-desantno-shturmovaya-diviziya-234-polk>; <https://iz dot ru/841214/2019-02-02/miting-v-chest-pobedy-v-stalingradskoi-bitve-organizovali-v-pskove>
- 233 https://vk dot com/@russia_desant-104-i-gvardeiskii-desantno-shturmovoij-krasnoznamennyi-ordena; <https://army-today dot ru/wch/32515>
- 234 <https://army-today dot ru/wch/74268>; <https://vkadety dot ru/ob-ipoteke/234-dshp.html>
- 235 <https://vk dot com/wall-127118757-446557>; <https://voenpro dot ru/celendar/den-chasti-237-gv-pdp>
- 236 <https://tass dot ru/armiya-i-opk/17127015>; <https://smotrim dot ru/article/3219205>
- 237 <https://www.pskov.kp dot ru/online/news/2386072/>; <https://mamasoldata.mybb dot ru/viewtopic.php?id=2017&p=3>
- 238 <https://vk dot com/club23417198>; <https://voenpro dot ru/celendar/17-noyabrya-den-chasti-1140-gv-artpolka-vdv>; <https://m.ok dot ru/group1140gv.dva/albums>; <https://pskov.bezformata dot com/listnews/gvardejskiy-artillerijskiy-polk/99754799/>
- 239 <https://www.pskov.kp dot ru/online/news/2241007/>; <https://ok dot ru/voyskovoep/album/59190085746739>
- 240 <https://iz dot ru/1132781/anton-lavrov-roman-kretcul/poleznaia-nagruzka-voenno-transportnoi-aviatcii-dobavit-polkov>; <https://army-today dot ru/wch/65451>; <https://smotrim dot ru/video/2608984>
- 241 <https://army-today dot ru/wch/62295>; <https://voinskiechasti dot ru/vozdushno-desantnye-voyska/vch62295>
- 242 <https://03rosrgvard dot ru/331-polk-vdv-kostroma/>; <https://svs-gru dot ru/331-y-gvardejskiy-vozdushno-desantnyj-polk/>; <https://vk dot com/kostroma331pdp>
- 243 <https://37kp dot ru/215-%D0%B9-%D0%BE%D1%82%D0%B4%D0%B5%D0%B-%D1%8C%D0%BD%D1%8B%D0%B9-%D1%80%D0%B0%D0%B7%D0%B2%D0%B5%D0%B4%D0%B1%D0%B0%D1%82-98-%D0%B9-%D0%B2%D0%B4%D0%B4/>; <https://armiyapro.ru/srochnaya-sluzhba/vojskovaya-chast-62295-217-j-pdp-vdv>; https://vk dot com/wall-106160452_487679; <https://pomnirod dot ru/materialy-k-statyam/rossiya-poslerevolucionnaya/voennye/voinskie-podrazdeleniya1/desantura/127-ya-gvardejskaya-strelkovaya-diviziya/98-ya-gvardejskaya-vozdushno-desantnaya-diviziya/215-ya-otdelnaya-gvardejskaya-razvedyvatelnaya-rotas-98-j-gvardejskoj-vozdushno-desantnoj-divizii.html>
- 244 <https://gtrk-kostroma dot ru/news/kostromskoy-1065-y-gvardejskiy-artpolk-otmetil-75-letie/>; https://rus-kostroma dot ru/news/41114-1065_mu_gvardejskomu_artillerijskomu_polku_75/
- 245 <https://voinskaya-chast dot ru/voinskie-chasti-v-gorodax/voinskie-chasti-goroda-ivanovo-i-ivanovskoj-oblasti.html>; <https://army-today dot ru/wch/ivanovo>
- 246 <https://prizivniku dot com/podrazdeleniya/106-tulskaya-diviziya-vdv>; <https://topwar dot ru/28447-106-gvardejskaya-vozdushno-desantnaya-diviziya.html>
- 247 <https://prizivniku dot com/podrazdeleniya/51-polk-vdv-tule>; <https://armiyapro dot ru/srochnaya-sluzhba/51-polk-vdv-v-tule-adres-istoriya-formirovaniya-uchastie-v-boevyh-dejstviyah>
- 248 <https://army-today dot ru/wch/41450>; <https://vk dot com/club8096629>
- 249 <https://myslo dot ru/city/people/person/odin-den-iz-zhizni-razvedchika>; <https://amalantra dot ru/106-diviziya-vdv/>
- 250 <https://mamasoldata.mybb dot ru/viewtopic.php?id=5439>; <https://wmj dot su/stati/2896-1182-y-gvardejskiy-artillerijskiy-polk.html>
- 251 <https://m.ok dot ru/voyskovoep/album/56814909063219>; <https://iohotnik dot ru/interesnye-fakty/286307-106-vdd.html>

- 252 <https://armiyapro dot ru/srochnaya-sluzhba/voinskaya-chast-32364-II-ya-dshb-mestonahozhdenie-kontakty>; <https://army-today dot ru/wch/32364>
- 253 <https://topwar dot ru/14508-ulyanovskaya-31-desantno-shturmovaya-brigada-iznutri-reportazh.html>; <https://army-today dot ru/wch/73612>
- 254 <https://vk dot com/club17007122>; <https://army-today dot ru/wch/71289>; <https://amalantra dot ru/83-brigada-vdv/>
- 255 <https://www.marshallcenter.org/en/publications/security-insights/spetsnaz-operational-intelligence-political-warfare-and-battlefield-role-0#toc-scouts-and-saboteurs>; <https://vk dot com/club62201917>; <http://xn--80adjlackxh6aem6d dot xn--p1ai/chast/vch-71298/>; <https://voinskaya-chast dot ru/voz-dushno-desantnye-vojska/voinskaya-chast-28337-45-gvardejskij-polk-specialnogo-naznacheniya.html>
- 256 <https://www.marshallcenter.org/en/publications/security-insights/spetsnaz-operational-intelligence-political-warfare-and-battlefield-role-0#toc-scouts-and-saboteurs>; <https://voinskayachast dot net/suhoputnie-voyska/specialnie/vch64044>; <https://voinskaya-chast dot ru/vooruzhennye-cily/cuxoputnye-vojska/specialnye/voinskaya-chast-64044.html>
- 257 <https://www.marshallcenter.org/en/publications/security-insights/spetsnaz-operational-intelligence-political-warfare-and-battlefield-role-0#toc-scouts-and-saboteurs>; <https://voinskayachast dot net/suhoputnie-voyska/specialnie/vch21208>; <https://armiyapro dot ru/srochnaya-sluzhba/vojskovaya-chast-21208-3-ya-obrsn>
- 258 <https://www.marshallcenter.org/en/publications/security-insights/spetsnaz-operational-intelligence-political-warfare-and-battlefield-role-0#toc-scouts-and-saboteurs>; <https://vm dot ru/news/1041290-putin-prisvoil-pochetnoe-zvanie-gvardejskaya-trem-podrazdeleniyam-rossijskoj-armii>; <https://voinskayachast dot net/suhoputnie-voyska/specialnie/vch51532>
- 259 <https://www.marshallcenter.org/en/publications/security-insights/spetsnaz-operational-intelligence-political-warfare-and-battlefield-role-0#toc-scouts-and-saboteurs>; <https://web.archive.org/web/20211028193114/http://www.kremlin.ru/acts/bank/43924>; <https://vk dot com/club54299826>; <https://army-today dot ru/wch/74854>
- 260 <https://www.marshallcenter.org/en/publications/security-insights/spetsnaz-operational-intelligence-political-warfare-and-battlefield-role-0#toc-scouts-and-saboteurs>; <https://voinskayachast dot net/suhoputnie-voyska/specialnie/vch54607>; <https://vk dot com/club25644164>; <https://web.archive.org/web/20190129181722/http://prezident.org/articles/ukaz-prezidenta-rf-16-ot-26-janvarja-2019-goda-27-01-2019.html>
- 261 <https://www.marshallcenter.org/en/publications/security-insights/spetsnaz-operational-intelligence-political-warfare-and-battlefield-role-0#toc-scouts-and-saboteurs>; <https://vk dot com/club16399820>; <https://spark-interfax dot ru/rostovskaya-oblast-aksaiski-raion/bu-voiskovaya-chast-inn-6102011274-ogrn-1026100666063-6906d994f899226ae-0531b9aa8c04bb6>
- 262 <https://www.marshallcenter.org/en/publications/security-insights/spetsnaz-operational-intelligence-political-warfare-and-battlefield-role-0#toc-scouts-and-saboteurs>; <https://voinskayachast dot net/suhoputnie-voyska/specialnie/vch55433>; <https://web.archive.org/web/20220531135733/http://publication.pravo.gov.ru/Document/View/0001202205300007>
- 263 <https://www.marshallcenter.org/en/publications/security-insights/spetsnaz-operational-intelligence-political-warfare-and-battlefield-role-0#toc-scouts-and-saboteurs>; <http://kremlin dot ru/acts/news/70778>; <https://vz dot ru/news/2023/3/27/1204926.html>; <https://incident.obozrevatel dot com/crime/anneksiya-kryima-rassekrechenyi-voennyye-chasti-rossii-novosti-segodnya.htm>

